

List of Contents

Compressed Air Accessories



Couplings	Micro-Coupling DN2,7	2	
	Mini-Coupling DN5	3	
	Multi-Coupling DN5,5	4	
	Standard Coupling DN7,2 (Brass and Steel)	5	
	Two And Three Way Distributor, Ball Swivel Connector DN7,2	6	
	Safety Coupling With Push Button DN7,4	7 - 8	
	Steel Plug With Euro Profile DN7,2	8	
	Safety Coupling DN7,8	9 - 10	
	High Flow Coupling DN7,8	11	
	Coupling DN10	12	
	Garage Coupling DN12	13	
	GEKA Coupling	14	
	Threaded Connections	Threaded Fitting	15 - 18
Hose Connection (Brass)		19 - 20	
High Speed Connection		21 - 25	
Rapid-Action Screw-Fitting For Plastic Hose		26 - 27	
Hose For High Speed Connection (PU)		25	
Hoses	Spiral Hose With Connector (PA, PU)	28 - 29	
	Automatic Runback Hose Reel	30	
	PVC Fabric Hose With Inlay	30	
	PVC Hose / Rubber-Hose (Blue Stripes) / Painting and Air Hose/Plastic Hoses (PE, PA 11)	31	
	Strainers	32	
	Accessories	Garage-Wall Holder/Teflon Band/ Compressed Air Special Oil/Compressor Oil	33
		Valves	Compact Ball Valve/Valve With DVGW-Approval
Shut-Off And Regulating Valve	35		
Drain Valve	36		
Air Distributor	36		
Manual Slide Valve (3/2-Way Valve)	37		
Non-Return Valve	38		
Safety Valves	Component-Tested Safety Valve DN6		39
	Component-Tested Safety Valve DN8		40
	Component-Tested Safety Valve DN10	41	
	Component-Tested Safety Valve DN24, 32, 48 High-Performance Safety Valve G1 – G2	42 - 43	
Blow-Off Valves	Classic and Mini (Without Component Test)	44	
Mufflers	Muffler Of Sintered Bronze	45	
	Muffler Of Plastic	46	
	Multi Chamber Muffler	46	
Pressure Gauges	Ø40, 50, 63	47 - 48	

Micro-Coupling DN2,7

Couplings

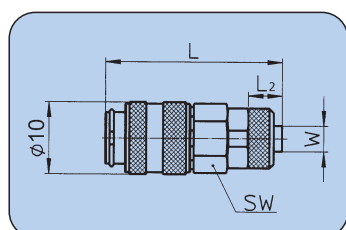
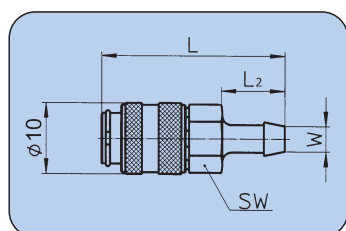
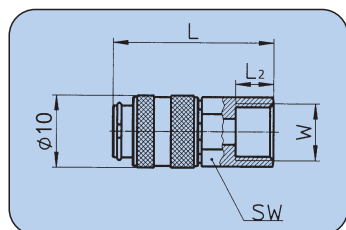
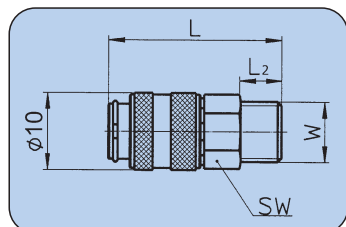

One side sealing one-handed quick release with extremely small dimensions and high pass at low pressure drop.

Connection Dimensions [mm]				Order No.
W	L	L ₂	SW	

Coupling with male thread

M5	26	5	9	310.001
G ^{1/8}	28	7	11	310.101

Plug with male thread

M5	18	5	7	310-010
G ^{1/8}	20	7	11	310-020

Coupling with female thread

M5	25	5	9	310.002
G ^{1/8}	28	7	12	310.102

Plug with female thread

M5	17	5	7	310-021
G ^{1/8}	18	7	12	310-030

Coupling with hose connection

LW3	35	13	-	310.105
LW4	35	13	-	310.103

Plug with hose connection

LW3	24	13	-	310-048
LW4	24	13	-	310-049

Coupling with rapid-action screw-fitting

4x3	34	7	9	310.084
5x3	34	7	9	310.094
6x4	34	7	9	310.104

Plug with rapid-action screw-fitting

4x3	7	25	7	310.184
5x3	7	25	7	310.194
6x4	5,8	24	-	310.204

Technical Data

Nominal rates of flow*	210NI/min
Max. operating pressure (P ₁)	16bar**
Min. operating pressure	1 bar
Operating temperature	-20°C up to +100°C
Mounting position***	any
Direction of flow	any
Material	
Housing	brass nickel plated
Seals	NBR
Spring	V2A

* measured at 6 bar pre-pressure (p₁) and Δp = 1 bar

** At higher pressures (up to PN35) connecting and disconnecting under pressure is not possible.

***Coupling preferably before plug in the direction of flow.

Remark

All DN2,7 plugs are compatible with all DN2,7 couplings.

Compatible with:
Rectus 20KA

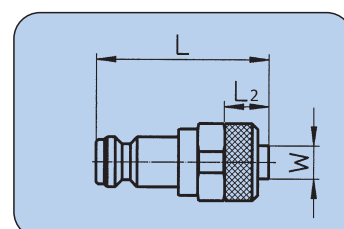
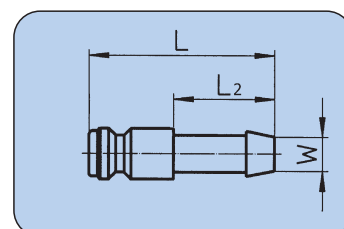
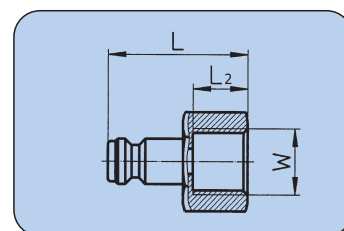
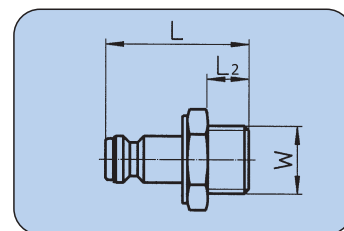



Mini Coupling DN5

Couplings



Remark

All DN5 plugs are compatible with all DN5 couplings.

Compatible with:
Rectus 21KA

One-hand-operation, rapid-action coupling with ball lock. Shut-off valve in the coupling, automatically unlocked when coupled. Without non-return valve in the plug.

Connection Dimensions [mm]			Order No.
W	L	SW	

Coupling with male thread

G ^{1/8}	36	14	320.101
G ^{1/4}	38	17	320.111

Plug with male thread

G ^{1/8}	28	14	320-020
G ^{1/4}	28	17	320-021

und detachably seal ring see page 27

Coupling with female thread

G ^{1/8}	37	14	320.102
G ^{1/4}	38	17	320.112

Plug with female thread

G ^{1/8}	25	14	320-030
G ^{1/4}	26	17	320-031

Coupling with hose connection

4mm	46	14	320.103
6mm	46	14	320.113

Plug with hose connection

4mm	33	-	320-049
6mm	33	-	320-050

Coupling with rapid-action screw-fitting

6x4 M10x1	41	14	320.104
8x6 M12x1	41	14	320.114

Plug with rapid-action screw-fitting

6x4 M10x1	33		320.204
8x6 M12x1	33		320.214

Technical Data

Nominal rates of flow*	500NL/min
Max. operating pressure (P _i)	16bar**
Min. operating pressure	1 bar
Operating temperature	-10°C up to + 90°C
Mounting position***	any
Direction of flow	any
Material	
Housing	brass nickel plated
Seals	NBR
Spring	V2A

* measured at 6 bar pre-pressure (p₁) and Δp = 1 bar

** At higher pressures (up to PN35) connecting and disconnecting under pressure is not possible.

***Coupling preferably before plug in the direction of flow.

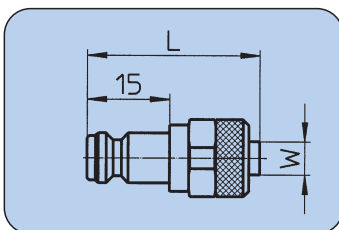
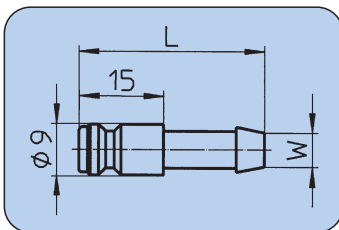
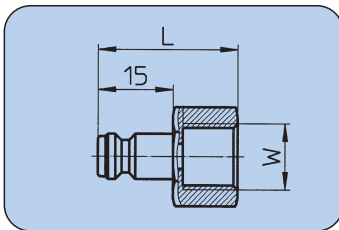
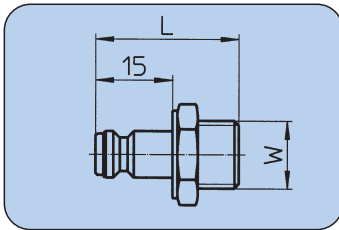
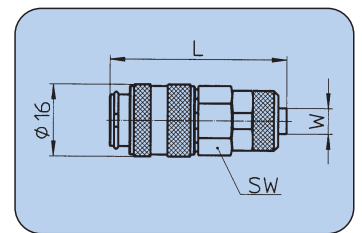
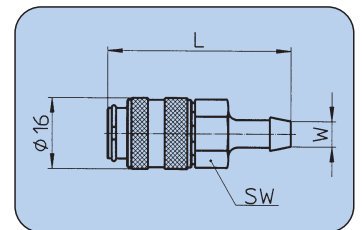
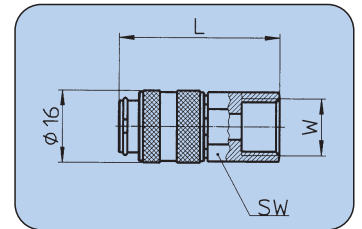
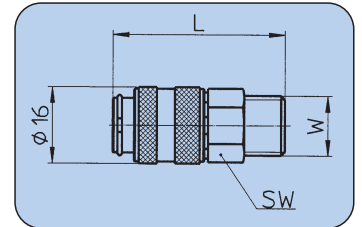
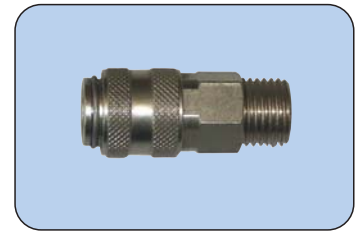

Multi-Coupling DN5,5

Couplings

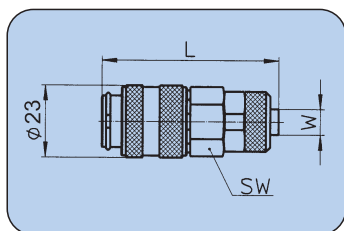
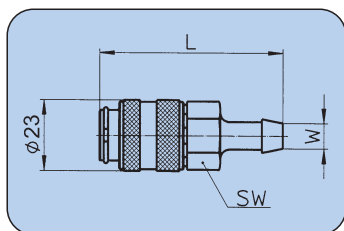
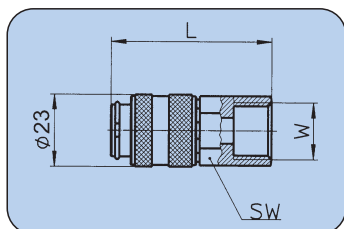
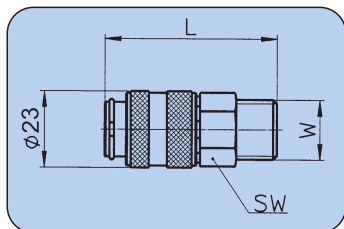
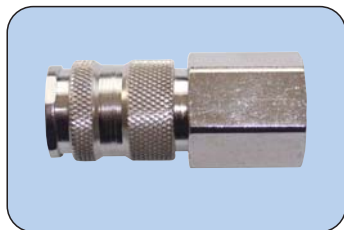

Industrial clutch with high flow performance. Especially suitable for use with gaseous media in the industry.

Conection Dimensions [mm]			Order No.
W	L	SW	

Coupling with male thread

G ^{1/4}	55	19	312.001
G ^{3/8}	55	19	312.021
G ^{1/2}	55	21	312.041

Plug with male thread

G ^{1/4}	38	17	312-053
G ^{3/8}	38	19	312-054
G ^{1/2}	40	24	312-057

Coupling with female thread

G ^{1/4}	56	19	312.002
G ^{3/8}	55	19	312.022
G ^{1/2}	58	24	312.042

Plug with female thread

G ^{1/4}	38	17	312-055
G ^{3/8}	38	19	312-056
G ^{1/2}	40	24	312-058

Coupling with hose connection

6mm	67	19	312.023
8mm	67	19	312.026
9mm	67	19	312.024
10mm	67	19	312.027
13mm	67	19	312.025

Plug with hose connection

6mm	51	-	312-050
8mm	51	-	312-075
10mm	51	-	312-076
13mm	51	-	312-052

Coupling with rapid-action screw-fitting

8x6	57	19	312.114
10x8	62	19	312.124

Coupling

with rapid-action screw-fitting + antikink

8x6	130	19	312.164
10x8	135	19	312.174

Technical Data

Nominal rates of flow*	700 NI/min
Max. operating pressure (P ₁)	16 bar**
Min. operating pressure	1 bar
Operating temperature	-20°C up to +100°C
Mounting position***	any
Direction of flow	any
Material	
Housing / Cover	brass nickel plated
Seals	NBR
Spring / Circlip	stainless steel 1.4310
Balls	stainless steel 1.4034

* measured at 6 bar pre-pressure (p₁) and Δp = 1 bar

** At higher pressures (up to PN 16) connecting and disconnecting under pressure is not possible.

***Coupling preferably before plug in the direction of flow.

Remark

All DN5,5 plugs are compatible with all DN5,5 couplings.

Compatible with:

ARO 210
CEJN 300
ewo 308
JWL 522 + JWL 532
ORION 44510
PARKER 50
RECTUS 14, 22 + 26

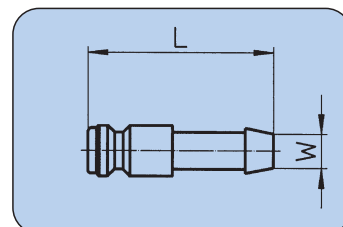
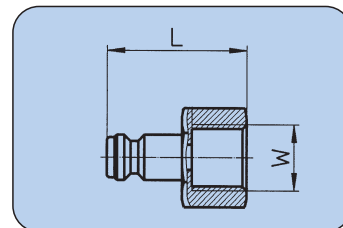
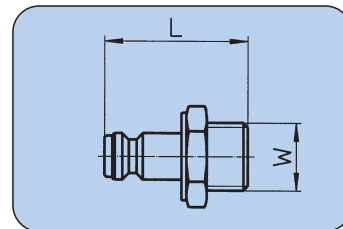



Standard Coupling DN7,2

Couplings



Remark

All DN7,2 plugs are compatible with all DN7,2 and DN7,8 couplings

One-hand-operation, rapid-action coupling with needle lock and non return valve. Shut-off valve in the coupling, automatically unlocked when coupled. Plug is without non-return valve. Steel couplings for use in situations subject to heavy wear.

Connection Dimensions [mm]				Order No.	
W	L	i	SW	Brass	Steel

Coupling with male thread

G ¹ / ₈	41	9	21	308.028 (D)	308.128
G ¹ / ₄	41	9	21	308.001 (D)	308.101
G ³ / ₈	41	9	21	308.021 (D)	308.121
G ¹ / ₂	41	10	21	308.041 (D)	308.141
G ¹ / ₂	45	10	24	308.081 (D)	-

Plug with male thread

G ¹ / ₈	31	7	14	308-061	-
G ¹ / ₄	33	9	17	308-053 (D)	308-153
G ³ / ₈	33	9	19	308-054 (D)	308-154
G ¹ / ₂	35	10	24	308-057 (D)	308-157

(D) = self-sealing (seal ring or coated thread)
undetachably seal ring see page 27

Coupling with female thread

G ¹ / ₈	41	8	21	308.029	308.129
G ¹ / ₄	41	8	21	308.002	308.102
G ³ / ₈	41	8	21	308.022	308.122
G ¹ / ₂	43	10	24	308.042	308.142

Plug with female thread

G ¹ / ₈	30	7	14	308-062	-
G ¹ / ₄	33	10	17	308-055	308-155
G ³ / ₈	33	10	19	308-056	308-156
G ¹ / ₂	35	10	24	308-058	308-158

Coupling with hose connection

6mm	57	25	21	308.023	308.123
8mm	57	25	21	308.026	308.126
9mm	57	25	21	308.024	308.124
10mm	57	25	21	308.027	308.127
13mm	57	25	21	308.025	308.125

Plug with hose connection

4mm	45	25	-	308-074	308-174
6mm	45	25	-	308-050	308-150
8mm	45	25	-	308-075	308-175
9mm	45	25	-	308-051	308-151
10mm	45	25	-	308-076	308-176
13mm	45	25	-	308-052	308-152

Plug with rapid-action screw-fitting

6x4mm	38	13	14	308.700	-
8x6mm	38	13	14	308.720	-
10x8mm	42	17	17	308.740	-

Technical Data

Nominal rates of flow*	1300 Nl/min
Max. operating pressure	16 bar**
Min. operating pressure	1 bar
Operating temperature	-10°C up to +90°C
Mounting position***	any
Direction of flow	any
Material	
Seals	NBR
Housing	brass steel
Spring	stainless steel

* measured at 6 bar pre-pressure (p₁) and Δp = 1 bar

** At higher pressures (up to PN35) connecting and disconnecting under pressure is not possible.

***Coupling preferably before plug in the direction of flow.

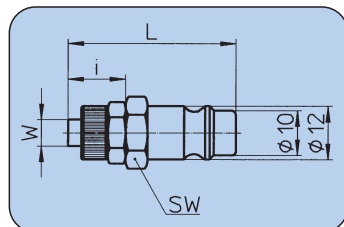
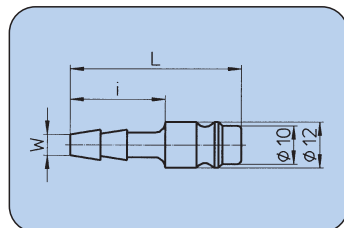
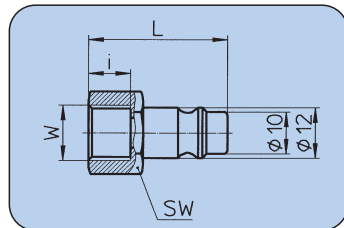
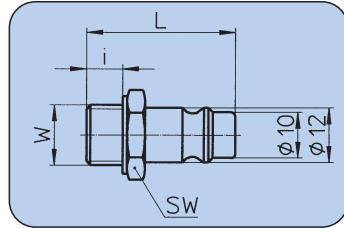
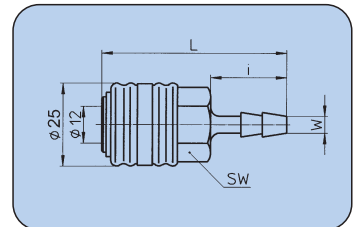
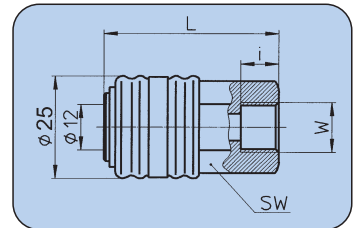
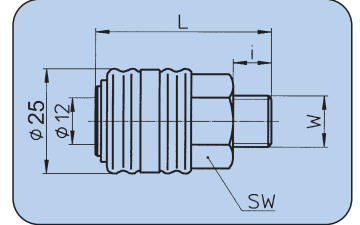

Option
Coupling and plug
outside nickel-plated

Standard Coupling DN7,2

Couplings



One-hand-operation, rapid-action coupling with needle lock and non return valve. Shut-off valve in the coupling, automatically unlocked when coupled. Plug is without non-return valve. Steel couplings for use in situations subject to heavy wear.

Conection W	Order No.	
	Brass	Steel

Two way distributor with male thread

G ^{1/4}	128.003	-
G ^{3/8}	128.004	128.104
G ^{1/2}	128.005	-

Two way distributor with female thread

G ^{1/4}	128.006	-
G ^{3/8}	128.007	-
G ^{1/2}	128.008	-

Three way distributor with male thread

G ^{1/4}	128.053	-
G ^{3/8}	128.054	128.154
G ^{1/2}	128.055	128.155

Two way distributor with female thread

G ^{1/4}	128.056	-
G ^{3/8}	128.057	-
G ^{1/2}	128.058	-

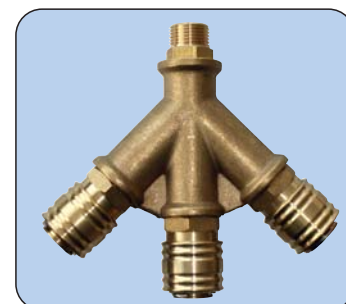
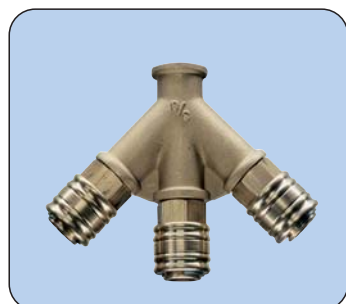

Ball Swivel Connector DN7,2

Couplings

Free-angle swivel avoids rotation and twisting. For increasing efficiency and installation flexibility. Protective rubber sleeve for dust-free operation and to prevent damage to coupling interior. Brass, nickel plated.

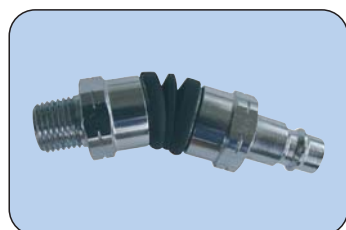

Connection W	Dimensions [mm]			Order No.
	L	i	SW1 / SW2	

male

G ^{1/4}	74	12	19	308-453
G ^{3/8}	74	13	19	308-454
G ^{1/2}	74	16	19 / 21	308-457

female

G ^{1/4}	74	12	19	308-455
G ^{3/8}	74	13	19	308-456
G ^{1/2}	74	13	19 / 25	308-458

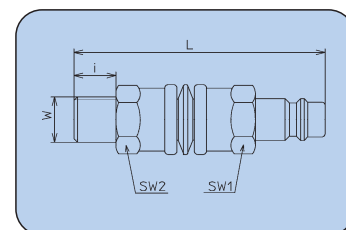

Note

not suitable for striking tools such as pneumatic screwdriver or Nailers.



Safety Coupling With Push Button DN7,4

Couplings



Remark

All DN7,4 plugs are compatible with all DN7,4, DN7,2 and DN7,8 couplings.

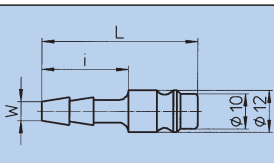
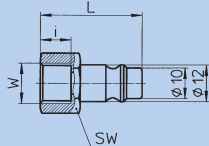
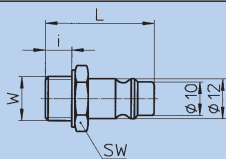
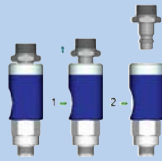

This safety coupling according ISO 4414 with a push-button avoids the so-called whip effect when the plug is decoupled. With the materials used, this high-quality coupling is characterized by stability and compactness.

Step 1: By a single actuation of the push button, the coupling is vented, the plug is further secured in the sleeve.

Step 2: When the push button is pressed a second time, the connector is unlocked and can be removed safely.

Connection Dimensions [mm]				Order No.
W	L	i	SW1 / SW2	

Coupling with male thread

G ^{1/4}	68,5	8	20	411.001
G ^{3/8}	69,5	9	20	411.021
G ^{1/2}	69,5	10	24	411.041

Plug with male thread

G ^{1/4}	33	8	17	308-153
G ^{3/8}	33	9	19	308-154
G ^{1/2}	33	10	24	308-157

Coupling with female thread

G ^{1/4}	68	10	20	411.002
G ^{3/8}	72,5	11	20	411.022
G ^{1/2}	73	11	24	411.042

Plug with female thread

G ^{1/4}	33	10	17	308-155
G ^{3/8}	33	10	19	308-156
G ^{1/2}	33	10	24	308-158

Coupling with hose connection

6mm	85,5	25	20	411.023
8mm	85,5	25	20	411.026
9mm	85,5	25	20	411.024
10mm	85,5	25	20	411.027
13mm	85,5	25	20	411.025

Plug with hose connection

6mm	45	25	-	308-150
8mm	45	25	-	308-175
9mm	45	25	-	308-151
10mm	45	25	-	308-176
13mm	45	25	-	308-152

Technical Data

Nominal rates of flow*	1800NI/min
Max. operating pressure (P _i)	12bar
Min. operating pressure	1bar
Operating temperature	-10°C up to + 90°C
Mounting position**	any
Direction of flow	any
Material	
Housing entry	brass nickel plated
Housing middle	aluminum anodized
Housing outlet	steel galvanized
Seals	NBR
Springs	stainless steel 1.4310
Shots	stainless steel 1.4034
Plugs	steel galvanized

* measured at 6bar pre-pressure (p₁) and Δp = 1bar

** Coupling preferably before plug in the direction of flow

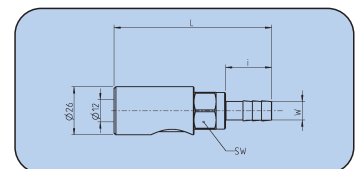
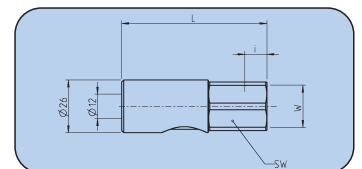
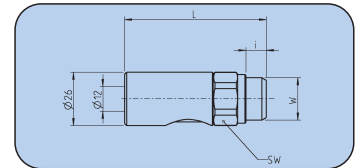

We recommend steel plugs when using this safety coupling.



Safety Coupling With Push Button DN7,4



Safety couplings with swivel connector allow turning the coupling, when being fixed-mounted, for bringing the push-button into a visible position.

Connection Dimensions [mm]				Order No.
W	L	i	SW1 / SW2	

Coupling with swivel connector male thread

G ¹ / ₄	76	6	20	411.201
G ³ / ₈	76	7	20	411.221
G ¹ / ₂	81	8	20	411.241

Coupling with swivel connector female thread

G ¹ / ₄	75	12	20	411.202
G ³ / ₈	77	12	20	411.222
G ¹ / ₂	79	13	24	411.242

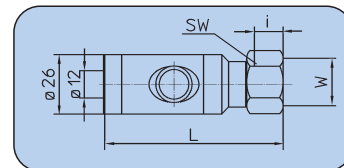
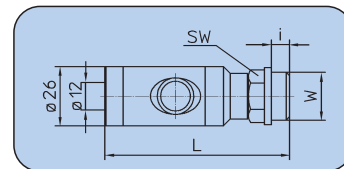

Technical Data

Nominal rates of flow*	1800 NI/min
Max. operating pressure (P₁)	12 bar
Min. operating pressure	1 bar
Operating temperature	-10°C up to + 90°C
Mounting position**	any
Direction of flow	any
Material	
Housing entry	brass nickel plated
Housing middle	aluminum anodized
Housing outlet	steel galvanized
Seals	NBR
Springs	stainless steel 1.4310
Shots	stainless steel 1.4034
Plugs	steel galvanized

* measured at 6 bar pre-pressure (p₁) and Δp = 1 bar

** Coupling preferably before plug in the direction of flow

We recommend steel plugs
when using this safety
coupling.



Steel Plug With Euro Profile DN7,2

Steel connectors and plugs are characterized by a longer life time compared to brass plugs.

Recommended for use with any safety couplings and high flow couplings of series 411, 455, 466 and 476!

Connection Dimensions [mm]				Order No.
W	L	i	SW1 / SW2	

with male thread

G ¹ / ₄	33	9	17	308-153
G ³ / ₈	33	9	19	308-154
G ¹ / ₂	35	10	24	308-157

with female thread

G ¹ / ₄	33	10	17	308-155
G ³ / ₈	33	10	19	308-156
G ¹ / ₂	35	10	24	308-158

with hose connection

4mm	45	25	-	308-174
6mm	45	25	-	308-150
8mm	45	25	-	308-175
9mm	45	25	-	308-151
10mm	45	25	-	308-176
13mm	45	25	-	308-152

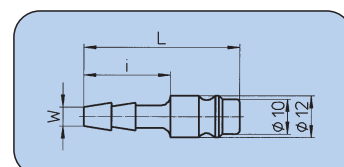
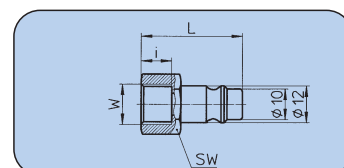
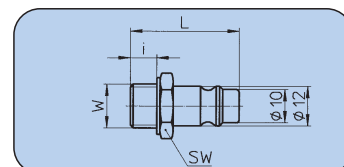
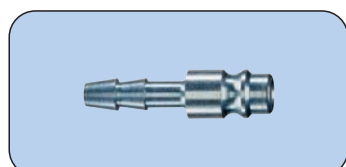
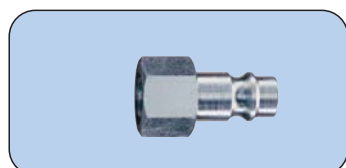
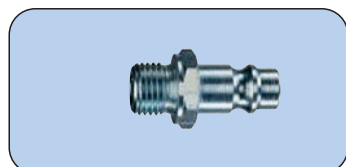



Safety Coupling DN7,8

Couplings

Remark

All DN7,8 plugs are compatible with all DN7,8 and DN7,2 couplings.

Safety coupling, **plastic sleeve** with two-stage relieving according ISO4414, DINEN983.

Stage I: After pushing the sleeve backwards the plug goes out one step and the remaining pressure escapes.

Stage II: Pushing the sleeve forwards, the plug release and can be disconnected without any danger. For longer wear we recommend only steel plugs.

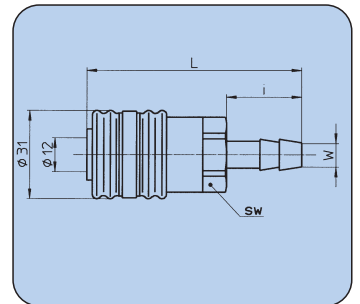
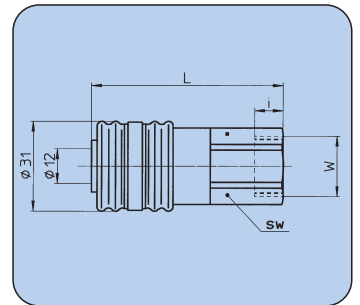
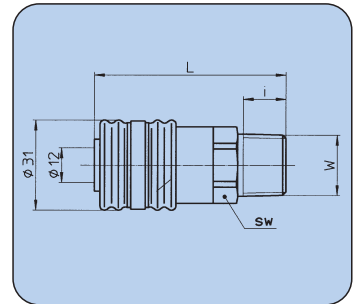

Connection Dimensions[mm]				Order No.
W	L	i	SW	

Coupling with male thread

G ^{1/4}	57	9	21	466.001
G ^{3/8}	57	9	21	466.021
G ^{1/2}	60	12	24	466.041

Plug with male thread

G ^{1/4}	33	8	17	308-153
G ^{3/8}	33	9	19	308-154
G ^{1/2}	33	10	24	308-157

Coupling with female thread

G ^{1/4}	60	12	21	466.002
G ^{3/8}	60	12	21	466.022
G ^{1/2}	62	14	24	466.042

Plug with female thread

G ^{1/4}	33	10	17	308-155
G ^{3/8}	33	10	19	308-156
G ^{1/2}	33	10	24	308-158

Coupling with hose connection

6mm	72	22	21	466.023
9mm	72	22	21	466.024
13mm	72	22	21	466.025

Plug with hose connection

6mm	45	25	-	308-150
9mm	45	25	-	308-151
13mm	45	25	-	308-152

Technical Data

Nominal rates of flow*	1800NI/min
Max. operating pressure (P _i)	8bar**
Min. operating pressure	1bar
Operating temperature	-10°C up to + 90°C
Mounting position***	any
Direction of flow	any
Material	
Housing	brass nickel plated
Cover	POM
Seals	NBR
Spring	V2A
Plug	steel galvanized

* measured at 6bar pre-pressure (p₁) and Δp = 1bar

** At higher pressures (up to PN 16) connecting and disconnecting under pressure is not possible.

***Coupling preferably before plug in the direction of flow.

Reference

Not recommended for direct connection to percussive tools such as impact wrenches.

Safety Coupling DN7,8

Couplings

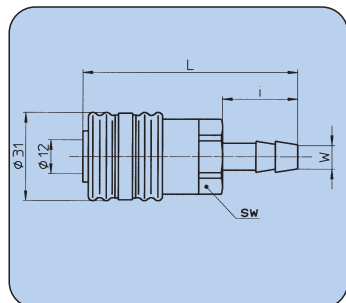
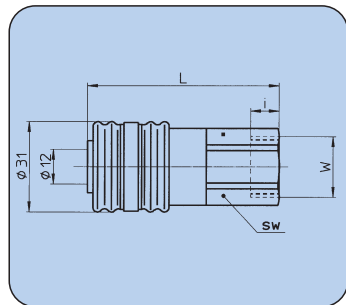
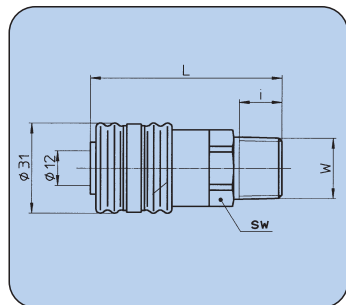

Safety coupling with two-stage relieving according ISO 4414, DINEN983. Lightly pushing back the sleeve opens the first lock. Coupling closes and at the same time presses the plug into the second position; the remaining pressure in the plug is able to escape. If the sleeve is pushed back again the plug is released and can be disconnected without danger. For longer wear we recommend only steel plugs.

Connection Dimensions [mm]				Order No.
W	L	i	SW	

Coupling with male thread

G ^{1/4}	62	9	24	455.001
G ^{3/8}	62	9	24	455.021
G ^{1/2}	62	12	24	455.041

Plug with male thread

G ^{1/4}	33	8	17	308-153
G ^{3/8}	33	9	19	308-154
G ^{1/2}	33	10	24	308-157

Coupling with female thread

G ^{1/4}	58	9	24	455.002
G ^{3/8}	58	9	24	455.022
G ^{1/2}	58	12	24	455.042

Plug with female thread

G ^{1/4}	33	10	17	308-155
G ^{3/8}	33	10	19	308-156
G ^{1/2}	33	10	24	308-158

Coupling with hose connection

6mm	77	25	24	455.023
8mm	77	25	24	455.026
9mm	77	25	24	455.024
10mm	77	25	24	455.027
13mm	77	25	24	455.025

with rubber protecting ring

Plug with hose connection

6mm	45	25	-	308-150
8mm	45	25	-	308-175
9mm	45	25	-	308-151
10mm	45	25	-	308-176
13mm	45	25	-	308-152

Technical Data

Nominal rates of flow*	1800NI/min
Max. operating pressure (P ₁)	8bar**
Min. operating pressure	1bar
Operating temperature	-10°C up to +90°C
Mounting position***	any
Direction of flow	any
Material	
Housing	brass nickel plated
Seals	NBR
Springs	stainless steel 1.4310
Shots and Pins	stainless steel 1.4034
Plugs	steel galvanized

* measured at 6bar pre-pressure (p₁) and Δp = 1 bar

** possible to 16bar in coupled condition (increased effort is necessary)

***Coupling preferably before plug in the direction of flow

Remark

All DN7,8 plugs are compatible with all DN7,8 and DN7,2 couplings.

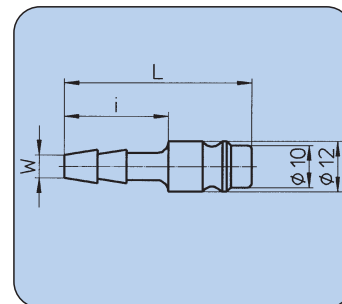
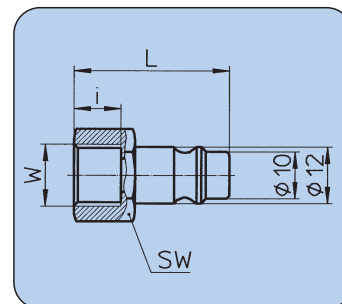
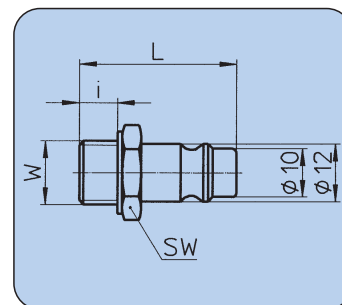
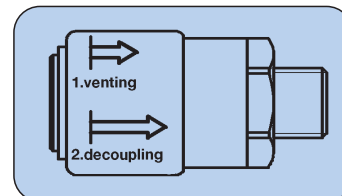

Reference

Not recommended for direct connection to percussive tools such as impact wrenches.



High Flow Coupling DN7,8

Couplings



Remark

All DN7,8 plugs are compatible with all DN7,8 and DN7,2 couplings.

One-hand - operation, rapide-action with needle lock and non return valve. Coupling with a high flow rate. A robust body for big pneumatic consumer.

Connection Dimensions [mm]				Order No.
W	L	i	SW	

Coupling with male thread

G ^{1/4}	63	12	19	476.001
G ^{3/8}	63	13	21	476.021
G ^{1/2}	63	15	24	476.041

Plug with male thread

G ^{1/4}	33	8	17	308-153
G ^{3/8}	33	9	19	308-154
G ^{1/2}	33	10	24	308-157

Coupling with female thread

G ^{1/4}	63	12	19	476.002
G ^{3/8}	63	15	21	476.022
G ^{1/2}	63	15	24	476.042

Plug with female thread

G ^{1/4}	33	10	17	308-155
G ^{3/8}	33	10	19	308-156
G ^{1/2}	33	10	24	308-158

Coupling with hose connection

6mm	76	25	19	476.023
8mm	76	25	19	476.026
9mm	76	25	19	476.024
10mm	76	25	19	476.027
13mm	76	25	19	476.025

Plug with hose connection

6mm	45	25	-	308-150
8mm	45	25	-	308-175
9mm	45	25	-	308-151
9mm	45	25	-	308-176
13mm	45	25	-	308-152

Technical Data

Nominal rates of flow*	2300NI/min
Max. operating pressure (P ₁)	16bar
Min. operating pressure	1 bar
Operating temperature	-10°C up to +100°C
Mounting position**	any
Direction of flow	any
Material	
Housing / Cover	brass nickel plated
Seals	NBR
Springs	stainless steel 1.4310
Shots and Pins	stainless steel 1.4034
Plugs	steel galvanized

* measured at 6bar pre-pressure (p₁) and Δp = 1 bar

** Coupling preferably before plug in the direction of flow

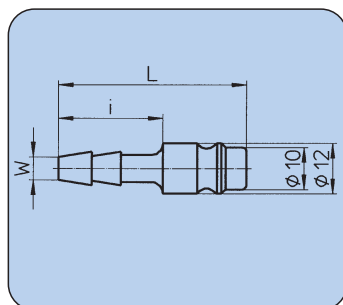
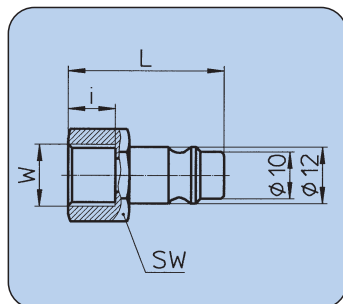
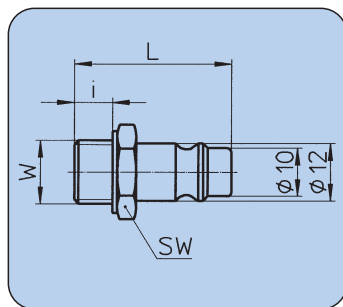
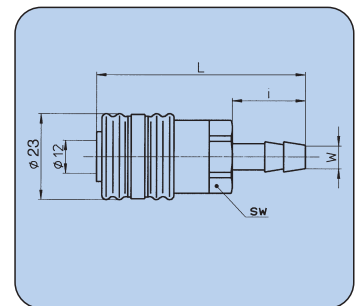
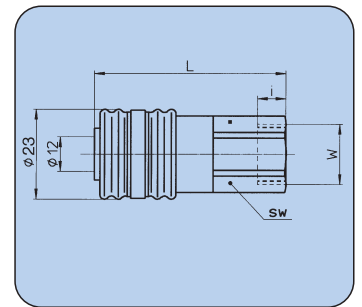
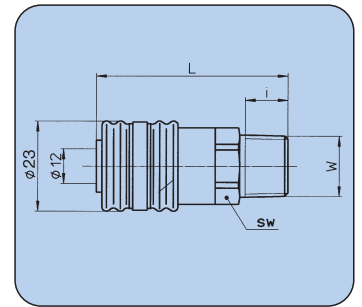
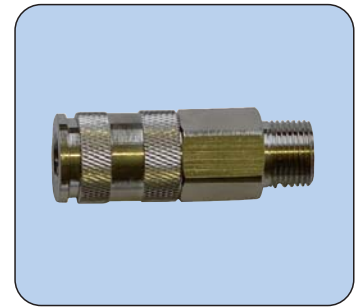

We recommend steel plugs when using this high flow coupling.

Coupling DN 10

Couplings

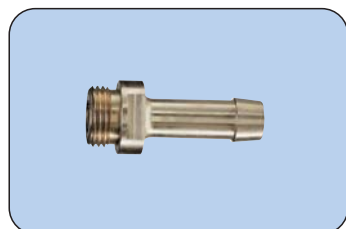
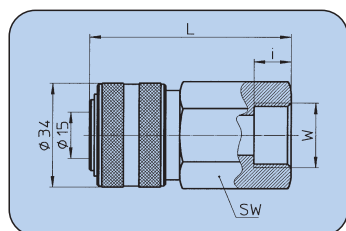
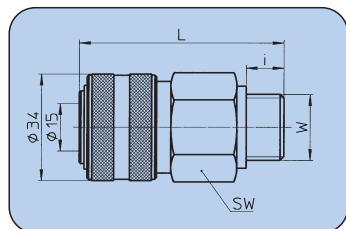
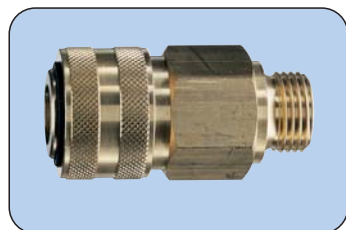

One-hand-operation, rapid-action coupling with needle lock and non return valve for higher flow capacity. Shut-off valve in the coupling, automatically unlocked when coupled. Plug is without non-return valve.

Connection	Dimensions [mm]				Order No.
	W	L	i	SW	

Coupling with male thread

G ^{1/2}	65	12	30	354.061
------------------	----	----	----	----------------

Plug with male thread (brass)

G ^{1/2}	42	12	27	354-059
------------------	----	----	----	----------------

Coupling with female thread

G ^{1/2}	65	12	30	354.071
------------------	----	----	----	----------------

Plug with female thread (brass)

G ^{1/2}	40	12	27	354-060
------------------	----	----	----	----------------

Two-Way Distributor

G ^{1/2}	128.04
------------------	---------------

Plug with hose connection (brass)

13mm	55	33	-	354-053
------	----	----	---	----------------

Plug with male thread G^{1/2} (brass)

13mm (1/2")	160-3
16mm (5/8")	160-3c
19mm (3/4")	160-3a

* With plug (male thread) the coupling part No. 354.071 can be modified to a hose connection.

Technical Data

Nominal rates of flow*	3200 NI/min
Max. operating pressure (P₁)	16 bar**
Min. operating pressure	1 bar
Operating temperature	-10°C up to +90°C
Mounting position***	any
Direction of flow	any
Material	
Housing	brass
Seals	NBR
Spring	stainless steel

* measured at 6 bar pre-pressure (p₁) and Δp = 1 bar

** At higher pressures (up to PN35) connecting and disconnecting under pressure is not possible.

***Coupling preferably before plug in the direction of flow.

Remark

All DN10 plugs are compatible with all DN 10 couplings.

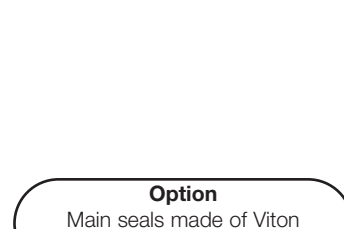
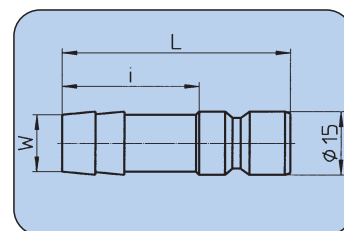
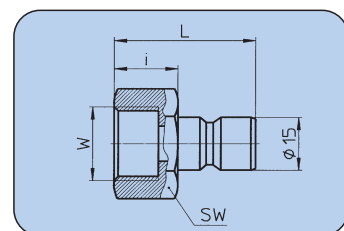
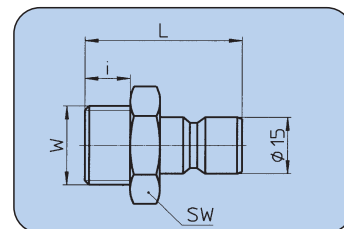

Option

Main seals made of Viton on request

Garage Coupling DN 12

Couplings

Remark

All DN 12 plugs are compatible with all DN 12 couplings.

Coupling with ball lock for high flow capacity. Non return valve in the coupling. With lip seal, thus also suitable for neutral fluids. Has rubber ring as protection against wear.

Connection Dimensions [mm]					Order No.
W	L	i	D	SW	

Coupling with male thread

G ^{1/2}	82	12	-	30	254.01
G ^{3/4}	82	12	-	30	254.03

Plug with male thread

G ^{1/4}	54	9	ø 6	17	254-27
G ^{1/2}	63	10	ø10	20	160-20

Coupling with female thread

G ^{1/2}	82	12	-	30	254.11
G ^{3/4}	82	12	-	30	254.13

Plug with hose connection

13mm	87	45	ø10,0	-	254-30
16mm	87	45	ø12,5	-	254-31
19mm	87	45	ø12,5	-	254-32

Two-Way Distributor

G ^{1/2}	128.03
------------------	---------------

Plug* with male thread G^{1/2}

13mm (1/2")	58	10	ø10	20	160-3
16mm (5/8")	58	10	ø11	20	160-3c
19mm (3/4")	58	10	ø12	20	160-3a

*With plug (male thread) the coupling part No. 254.11 can be modified to a hose connection.

Technical Data

Nominal rates of flow*	4000 NI/min
Max. operating pressure (P ₁)	16 bar**
Min. operating pressure	1 bar
Operating temperature (Air)	-10 °C up to +50 °C
(Water)	+5 °C up to +50 °C
Mounting position***	any
Direction of flow	any
Material	
Housing	brass
Seals	NBR
Spring	stainless steel

* measured at 6bar pre-pressure (p₁) and Δp = 1 bar

** At higher pressures (up to PN25) connecting and disconnecting under pressure is not possible.

***Coupling preferably before plug in the direction of flow.

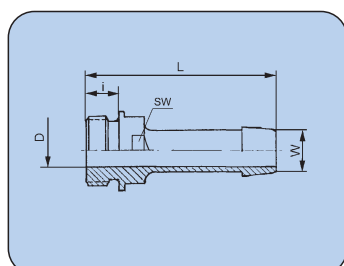
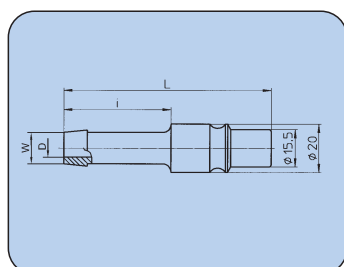
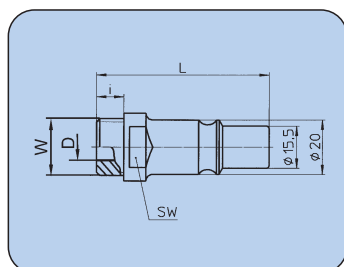
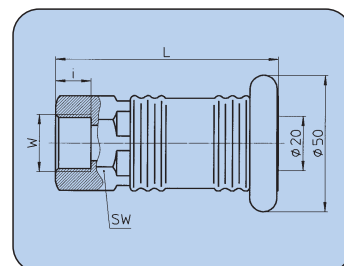
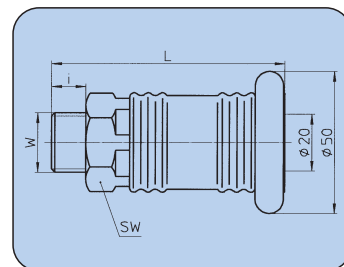
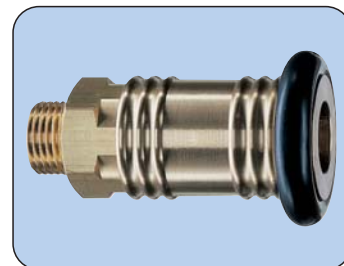



GEKA Coupling Couplings

For a save, easy and fast coupling and decoupling as well as to extend flexible hose pipes and -systems (Water-, Industry, Compressed air, suction and pressure hoses in dimensions G^{3/8}-10mm up to G1^{1/2}-38mm, also among themselves) and rigid pipes and -systems (metal and plastic pipes, thread dimensions G^{1/4} up to G1^{1/2}).

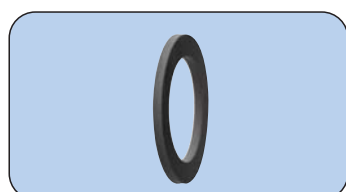
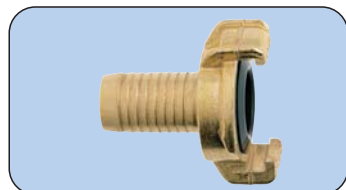

Connection	Dimensions [mm]			Order No.
SLW/G	NW	L	LT/T	

GEKA tail of hose

Plug with distinctive and hose saving ribbed profil for close hold of the hose.

For hose clamp and crimp sleeve.

10 (3/8")	7,5	40	28	516.150
13 (1/2")	10	40	28	516.151
16 (5/8")	13,5	44	32	516.152
19 (3/4")	17	44	32	516.153
25 (1")	21,5	50	37	516.154
32 (1 1/4")	28	60	48	516.155
38 (1 1/2")	34	63	48	516.156

GEKA SH tail of hose

Vacuum and high pressure. With threaded ring (threaded ring back screw, clutch, dress threaded ring).

13 (1 1/2")	10	67	31	516.361
19 (3/4")	15	71	35	516.362
25 (1")	20	76	42	516.363
32 (1 1/4")	28	82	46	516.364

GEKA form sealing ring SH PU = 10 St.

NBR (insert), black -30°C to +100°C	516-9
Retaining ring (brass) to stabilize the form sealing ring SH	516-10

GEKA threaded part

female thread

thread laterally with flat sealing ring SBR (up to 100°C)

G ^{1/4}	11	21	9,5	516.200
G ^{3/8}	11	21	9,5	516.201
G ^{1/2}	14	21	9,5	516.202
G ^{3/4}	19	22	10,5	516.203
G1	23	23	11	516.204
G1 1/4	23	28	13,5	516.205
G1 1/2	23	29	14	516.206

male thread

G ^{1/4}	8	22	8	516.210
G ^{3/8}	11,5	22	8	516.211
G ^{1/2}	15	22	8	516.212
G ^{3/4}	20	22	8	516.213
G1	23	22	8	516.214
G1 1/4	23	26	13	516.215
G1 1/2	23	26	13	516.216

GEKA blind coupling

-	-	27	15	516.174
---	---	----	----	----------------

GEKA high performance form sealing ring PU = 10 St.

NBR (insert), black -30°C to +100°C	516-6
NBR - foodstuff resistant, red -30°C to +100°C (KTW-approval)	516-7
EPDM, black - yellow marked -50°C to +150°C	516-8

GEKA flat sealing ring SBR (bis +100°C)

for threaded part with inside thread PU = 10 St.

Dimensions ca.	13 x 8 x 1,5	516-1
	17 x 11 x 1,5	516-2
	20,5 x 14 x 1,5	516-3
	26 x 18 x 2	516-4
	33 x 23 x 2	516-5

Locking nubs for best safety to avoid to release of the connection also in clutched pressureless state.

The claws have a uniform distance of 40mm.

Form sealing ring = NBR.

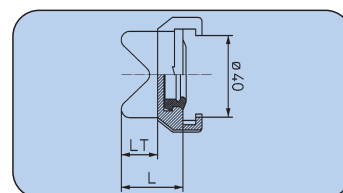
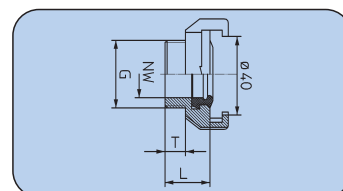
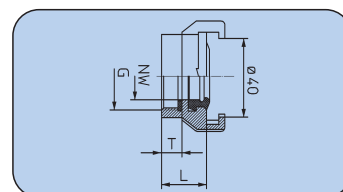
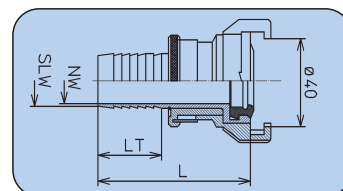
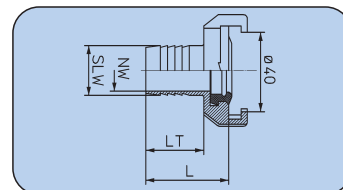

Technical Data

Brass CW617N (CuZn40Pb2) acc. DIN 50930/6

operating pressure (Form sealing ring) > 40bar (static benchmarked)

explosion limit (Form sealingring) > 80 bar (static benchmarked)

Vacuum resistant (Form sealing ring) up to 10m Water column, WS (static benchmarked)

Threaded Fitting

Threaded Connections

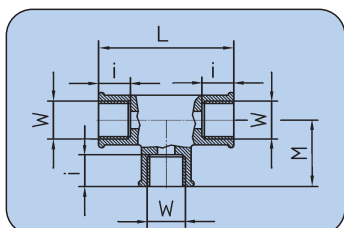
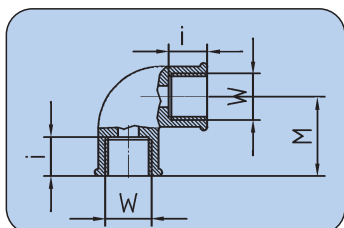
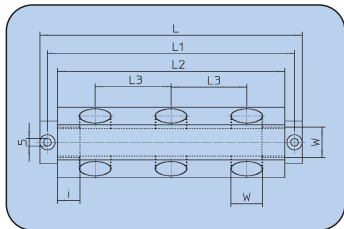
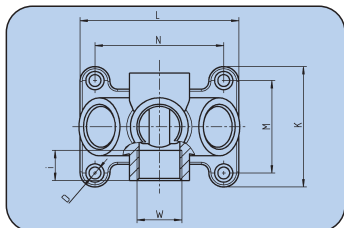
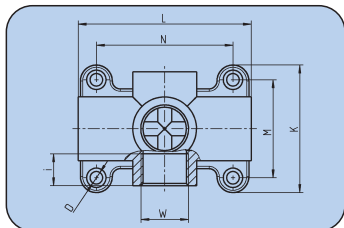
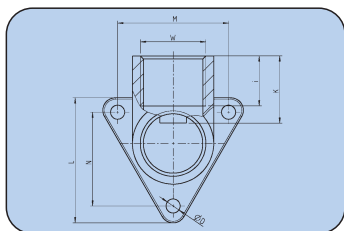
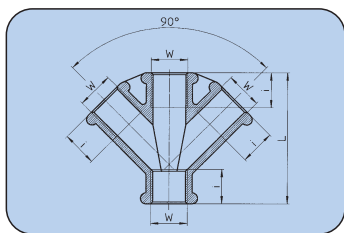

Thread	Dimensions [mm]							Order No.
	W	L	M	N	K	i	D	

Distributor (3-Way and 4-Way)

3xG ³ / ₈	48	-	-	-	14	-	121-35
3xG ¹ / ₂	54	-	-	-	15	-	121-50
4xG ³ / ₈	61	-	-	-	14	-	121-34
4xG ¹ / ₂	67	-	-	-	18	-	121-54

Ceiling elbow (90° for wall fastening)

2xG ³ / ₈	35	30	26	18,5	11	4,5	121-55
2xG ¹ / ₂	40	35,5	30	21,5	16	4,5	121-56
2xG ³ / ₄	51	45	39	28	13	4,5	121-57

Distributor with 5 outlets G¹/₂

5 x G ¹ / ₂	74	43,5	59	57	15	5,5	121-58
-----------------------------------	----	------	----	----	----	-----	---------------

Distributor with 5 outlets G¹/₂

5 x G ¹ / ₂	74	43,5	59	57	15	5,5	121-59
-----------------------------------	----	------	----	----	----	-----	---------------

Thread	Dimensions [mm]						Order No.
	W	L	L1	L2	L3	i	

Distribution block galvanized steel

6xG ¹ / ₂	123	113	100	50	14	121-60
8xG ¹ / ₂	173	163	150	50	14	121-61

Thread	Dimensions [mm]				Order No.
	W	DN	L	M	

90° Elbow with female thread

2xG ¹ / ₈	6	20	-	8	185.182
2xG ¹ / ₄	8	20	-	10	185.183
2xG ³ / ₈	15	22,5	-	11	185.185
2xG ¹ / ₂	19	29	-	15	185.187
2xG ³ / ₄	25	33	-	16	185.188
2xG1	30	40,5	-	20	185.189

T-Piece with female thread

3xG ¹ / ₈	8	36	18	9	185.197
3xG ¹ / ₄	11	36	19	10	185.196
3xG ³ / ₈	15	44	23	12	185.195
3xG ¹ / ₂	19	59	29,5	17	185.194
3xG ³ / ₄	25	68	34	15	185.193
3xG1	30	78	39	22	185.192

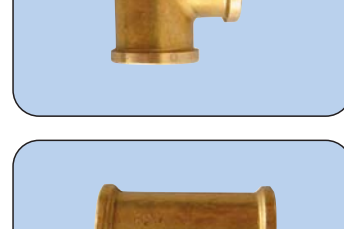
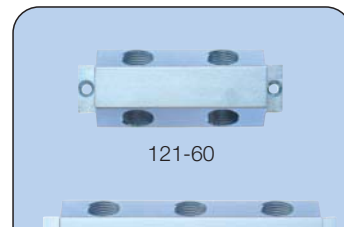
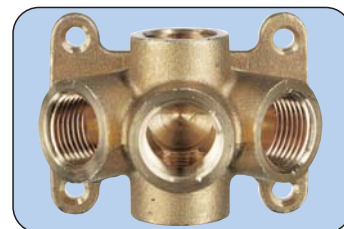
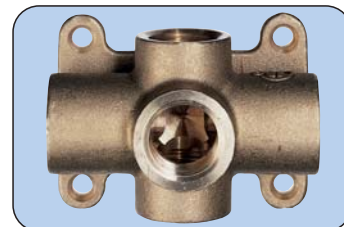

Threaded Fitting

Threaded Connections

Some of the thread connectors are equipped with a cone for attaching a hose connector with ball nipple seal.

Thread WxV	Dimensions [mm]					Order No.
	L	i	k	d	SW	

Double Nipple

For connecting compressed air units or installations of similar equipment. (without cone)

male, long – with Cone (45°) EN560

G ¹ / ₈ x G ¹ / ₈	29	9,5	9,5	5	12	185.29
G ¹ / ₄ x G ¹ / ₈	32	12	9,5	5	14	185.30
G ¹ / ₄ x G ¹ / ₄	34	12	12	7	14	185.33
G ³ / ₈ x G ¹ / ₄	36	13,5	12	7	17	185.53
G ¹ / ₄ x G ¹ / ₂	38	12	15,5	7	22	185.54
G ³ / ₈ x G ³ / ₈	37	13,5	13,5	10	17	185.55
G ¹ / ₂ x G ³ / ₈	40	15,5	13,5	10	22	185.75
G ¹ / ₂ x G ¹ / ₂	44	15,5	15,5	12	22	185.77
G ¹ / ₂ x G ³ / ₄	43	15	15	12	30	185.78
G ³ / ₄ x G ³ / ₄	42	15	15	19	30	415-13*
G ³ / ₄ x G1	50	15	16	19	36	415-15
G1 x G1	55	16	16	22	36	415-14*

* without cone

male thread, short – with Cone (45°) EN560

G ¹ / ₈ x G ¹ / ₈	19	7	7	5	12	185.029
G ¹ / ₈ x G ¹ / ₄	20,5	7	8,5	5	14	185.030
G ¹ / ₄ x G ¹ / ₄	22	8,5	8,5	7	14	185.033
G ¹ / ₄ x G ³ / ₈	24	8,5	9,5	7	17	185.053
G ¹ / ₄ x G ¹ / ₂	25,5	8,5	11	7	22	185.054
G ³ / ₈ x G ³ / ₈	25	9,5	9,5	10	17	185.055
G ³ / ₈ x G ¹ / ₂	26,5	9,5	11	10	22	185.075
G ¹ / ₂ x G ¹ / ₂	28	11	11	12	22	185.077
G ¹ / ₂ x G ³ / ₄	33	11	14	12	30	185.078
G ³ / ₄ x G ³ / ₄	36	14	14	19	30	185.013
G ³ / ₄ x G1	40	14	16	19	36	185.015
G1 x G1	42	16	16	22	36	185.014
G ¹ / ₂ x G ¹ / ₂	50	20	20	36	50	280-228
G2 x G2	55	20	20	40	65	454-9

female-, male thread

G ¹ / ₈ x G ¹ / ₈	20	8	8	5	14	185.129
G ¹ / ₄ x G ¹ / ₄	24	10	10	8	17	185.133
G ³ / ₈ x G ³ / ₈	29	11	12	10	22	185.155
G ¹ / ₂ x G ¹ / ₂	30	12	12	15	26	185.177
G ¹ / ₈ x G ¹ / ₄	22	8	10	8	14	185.130
G ¹ / ₄ x G ¹ / ₈	22	10	8	5	17	185.131
G ¹ / ₄ x G ¹ / ₂	27	10	12	10	22	185.132
G ³ / ₈ x G ¹ / ₄	27	11	10	8	22	185.153
G ³ / ₈ x G ¹ / ₂	29	11	12	13	22	185.154
G ¹ / ₂ x G ³ / ₈	30	12	12	10	26	185.175
G ¹ / ₂ x G ³ / ₄	34	12	16	17	32	185.176
G ³ / ₄ x G ¹ / ₂	37	15	16	15	32	185.178

Thread WxV	Dimensions [mm]					Order No.
	DN	L	i	k	SW1 SW	

male thread, solvable (3-part) with conical thread

R ¹ / ₈ x R ¹ / ₈	5,3	27	9	9	5	15	185.311
R ¹ / ₈ x R ¹ / ₄	5,3	30	9	12	5	15	185.312
R ¹ / ₄ x R ¹ / ₄	6,3	34	12	12	6	19	185.322
R ¹ / ₄ x R ³ / ₈	6,3	35	12	13	6	19	185.324
R ³ / ₈ x R ³ / ₈	8,5	36	13	13	8	22	185.344
R ¹ / ₂ x R ¹ / ₂	13	44	16	16	12	27	185.366
R ³ / ₄ x R ³ / ₄	15	52	18	18	14	36	185.388
R1 x R1	20	65	22	22	19	46	185.399

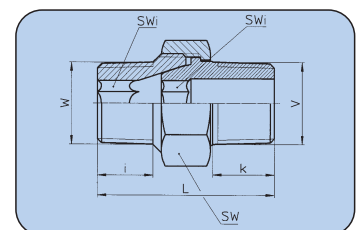
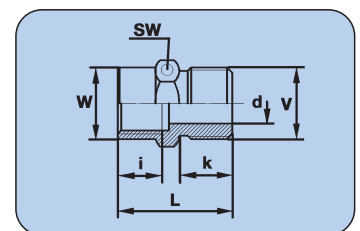
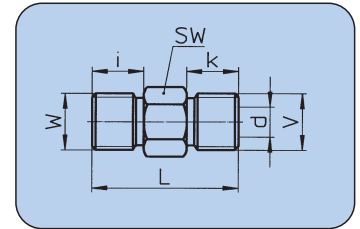
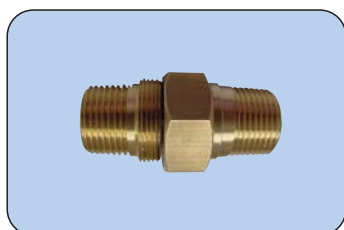
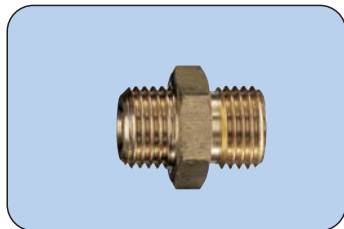
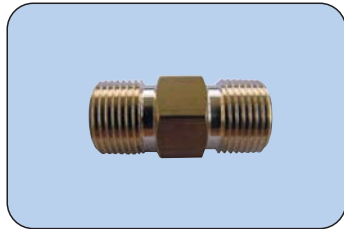

Threaded Fitting

Threaded Connections

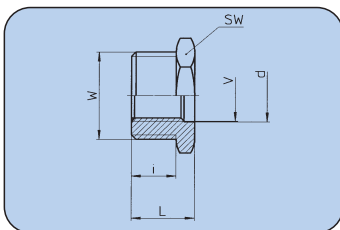
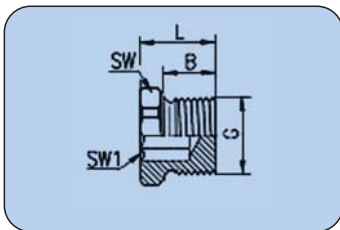
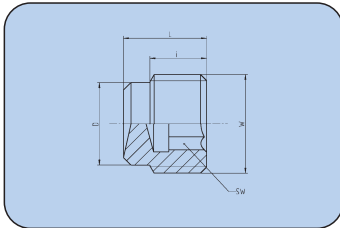
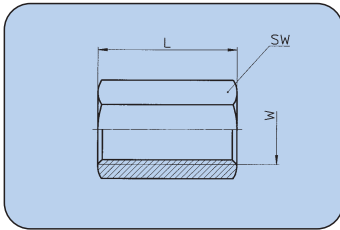

Thread	Dimensions [mm]		SW	Order No.
	W	L		

Sleeve (2-Way)

G 1/8	22	14	185.110
G 1/4	26	17	185.111
G 3/8	26	22	185.112
G 1/2	30	27	185.113
G 3/4	33	32	185.114
G 1	35	40	185.115

Thread	Dimensions [mm]				Order No.
	L	i	D	SW	

Screw plug

G 1/8	8	5	8	5	323-14
G 1/4	11	7	11	6	280-127
G 3/8	10	8	14	8	447-28
G 1/2	12	8	18	10	424-67

Thread	Dimensions [mm]				Order No.
	L	B	SW1	SW	

Blind plug with external and internal hexagon

and with turned sealing surface for sealing ring DIN 7603

G 1/8	10	6,5	5	14	185.160
G 1/4	13	8,5	8	17	185.161
G 3/8	15	10,5	10	19	185.162
G 1/2	19	13,5	12	24	185.163
G 3/4	20	14,0	14	32	185.164
G 1	22	16,0	17	36	185.165

Thread	Dimensions [mm]				Order No.
	W x V	L	i	d	

Reduction with hexagon nut

For reducing female threads or expanding male threads.

G 1/4 x G 1/8	12	9	10	17	1117
G 3/8 x G 1/8	12	8,5	10	19	322-18
G 3/8 x G 1/4	12	8,5	13,5	19	1068
G 1/2 x G 1/4	15,5	11,5	13,5	22	1191
G 1/2 x G 3/8	15,5	11,5	17	22	1018
G 3/4 x G 1/2	18	12	21	32	1292
G 1 x G 3/4	18	12	27	36	1193
G 1 1/2 x G 1/4	21	15	42,5	50	409-81
G 2 x G 1/4	30	20	43	65	417-50
G 2 x G 1/2	30	20	49	65	417-45

Technical Data

Max. operating pressure (P ₁)	63 bar (PN63)
Operating temperature	-10 °C up to +90 °C
Mounting position/Direction of flow	any
Material	brass

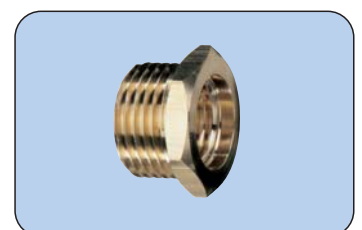
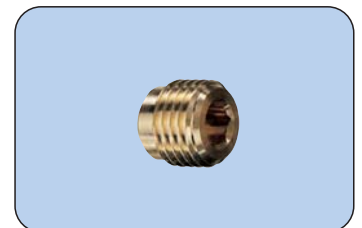
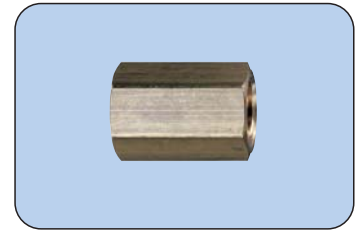

Threaded Fitting

Threaded Connections

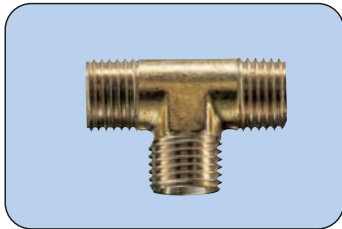
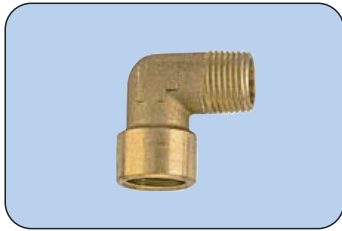
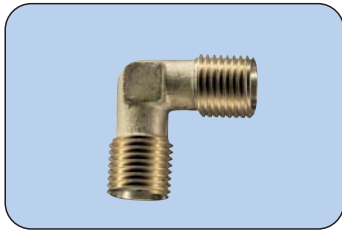

Thread W	Dimensions [mm]					Order No.
	DN	L	M	i	SW	

90° Elbow male thread with cone

G 1/8	5	18	18	10	10	185.82
G 1/4	7	22	22	11	13	185.83
G 3/8	8	27	27	15	17	185.85
G 1/2	12	26	26	13	21	185.87
G 3/4	19	40	40	16	25	185.88*
G 1	25	45	45	18	30	185.89*

* without cone

90° Elbow with female / male thread

G 1/8	6	18,5	21,0	8,0	10	185.42
G 1/4	8	23,5	25,5	11,0	13	185.43
G 3/8	11	26,0	28,0	11,5	17	185.45
G 1/2	15	31,0	33,5	14,0	21	185.47
G 3/4	19	33,0	36,5	16,0	25	185.48
G 1	24	39,0	45,0	19,0	30	185.49

Thread W	Dimensions [mm]					Order No.
	DN	L	M	i	SW	

T-Piece male thread with cone

G 1/8	5	35	17	7	10	185.97
G 1/4	8	47	24	12	13	185.96
G 3/8	9	52	26	12	17	185.95
G 1/2	12	54	27	13	21	185.94*
G 3/4	19	80	38	19	25	185.93*
G 1	25	90	42	20	30	185.92*

* without cone

T-Piece with female / male / female thread

G 1/8	6	42	18,5	8,0	10	185.62
G 1/4	8	51	23,5	11,0	13	185.63
G 3/8	11	56	26,0	11,5	17	185.65
G 1/2	15	67	31,0	14,0	21	185.67
G 3/4	19	73	33,0	16,5	25	185.68
G 1	24	90	39,0	19,0	30	185.69

T-Piece with female / female / male thread

G 1/8	6	39,5	21,0	8,0	10	185.12
G 1/4	8	49,0	23,5	11,0	13	185.13
G 3/8	11	54,0	28,0	11,5	17	185.15
G 1/2	15	64,5	33,5	14,0	21	185.17
G 3/4	19	69,5	36,5	16,5	25	185.18
G 1	25	84,0	45,0	19,0	33	185.19

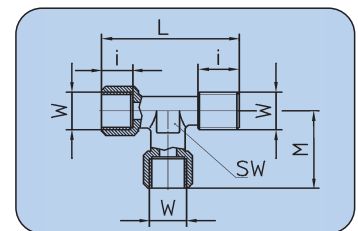
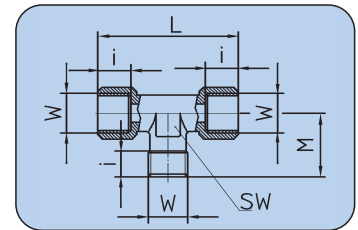
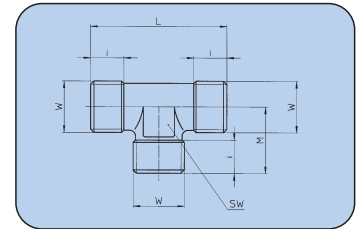
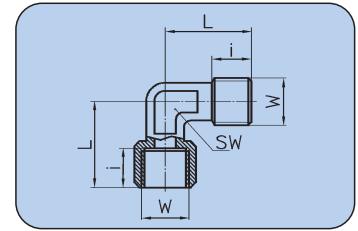
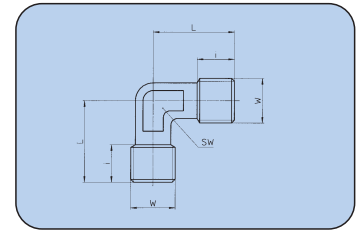

Technical Data

Max. operating pressure (PN)

63 bar

Operating temperature

-10°C to +90°C

Mounting position

any

Direction of flow

any

Material

brass

Hose Connection

Threaded Connections

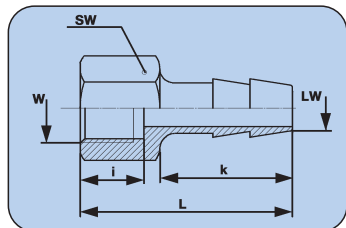

Thread	Hose LW	Dimensions [mm]			Order No.
		L	i/K	SW	

Hose Tail

with female thread

G ^{1/8}	4	33	9/22	12	113-9
G ^{1/8}	6	36	9/25	12	113-10
G ^{1/8}	9	36	9/25	14	113-11
G ^{1/4}	4	36	12/22	17	113-12
G ^{1/4}	6	40	12/25	17	113-13
G ^{1/4}	9	40	12/25	17	113-14
G ^{1/4}	13	45	12/30	17	113-15
G ^{3/8}	6	42	14/25	19	113-16
G ^{3/8}	9	42	14/25	19	113-17
G ^{3/8}	13	47	14/30	19	113-18
G ^{1/2}	6	42	14/25	24	113-19
G ^{1/2}	9	42	14/25	24	113-20
G ^{1/2}	13	47	14/30	24	113-21
G ^{3/4}	9	47	19/25	32	113-22
G ^{3/4}	13	52	19/30	32	113-23
G ^{3/4}	19	58	19/36	32	113-24
G1	19	60	20/36	36	113-31
G1	25	66	20/42	36	113-32
G1	32	70	20/46	36	113-33

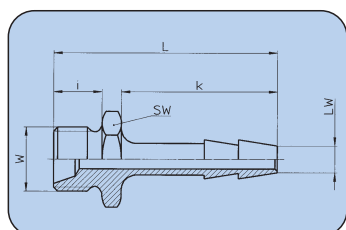
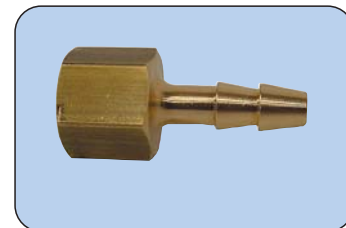

Thread	Hose LW	Dimensions [mm]			Order No.
		L	i/K	SW	

Hose Tail

with male thread and inner cone 45°

G ^{1/8}	4	34	8/22	14	113-41
G ^{1/8}	6	37	8/25	14	113-51
G ^{1/8}	9	37	8/25	14	113-52
G ^{1/4}	4	36	10/22	17	113-68
G ^{1/4}	6	40	10/25	17	113-31a
G ^{1/4}	9	40	10/25	17	113-40a
G ^{1/4}	13	45	10/30	17	113-71
G ^{3/8}	6	43	12/25	17	113-32a
G ^{3/8}	9	43	12/25	17	113-34a
G ^{3/8}	13	48	12/30	19	113-43
G ^{1/2}	6	44	12/25	24	113-67
G ^{1/2}	9	44	12/25	24	113-66
G ^{1/2}	13	49	12/30	24	113-44
G ^{3/4}	9	49	14/25	32	113-25
G ^{3/4}	13	54	14/30	32	113-26
G ^{3/4}	19	58	14/36	32	113-27
G1	19	60	16/36	36	113-28
G1	25	66	16/42	36	113-29
G1	32	70	16/46	36	113-30

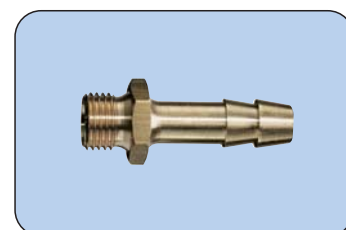

Technical Data

Max. operating pressure (PN)
40 bar

Operating temperature
-10°C up to +90°C

Mounting position
any

Direction of flow
any

Material
brass

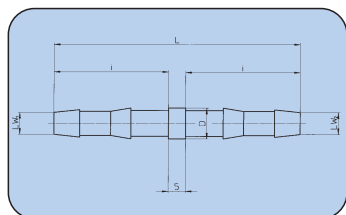

Hose LW ₁	Hose LW ₂	Dimensions [mm]			Order No.
		L	i	D	

Double Hose Connector

ENISO560 (DIN 8542)

4	4	64	29,5	8	113.00
6	6	72	33,5	9	113.01
6	8	72	33,5	12	113.02
9	9	72	33,5	12	113.03
13	13	72	33,5	16	113.04

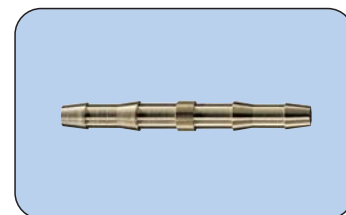

Hose Connection

Threaded Connections

Hose Connection

Hose connections consist of a connector plug - allowing the hose to be slipped on and secured with a hose clamp - and a threaded part, either male or female with a ball seal.

Thread	Hose LW	Dimensions [mm]			Order No.
		L	i/K	SW	

Detachable Hose Tails

Consist of hose plug with ball seal and swivel nut with adaptor.

Thread	Hose LW	Dimensions [mm]			Order No.
		L	i/K	SW	
G ^{1/8}	4	43	9/25	12	197.06
G ^{1/8}	6	43	9/25	12	197.07
G ^{1/4}	4	43	9/28	17	197.01
G ^{1/4}	6	43	9/25	17	197.02
G ^{1/4}	9	43	9/29	17	197.03
G ^{3/8}	4	49	9/31	19	198.01
G ^{3/8}	6	43	9/25	19	198.02
G ^{3/8}	9	43	9/28	19	198.03
G ^{3/8}	13	43	9/28	19	198.04*
G ^{1/2}	6	43	9/25	24	199.02
G ^{1/2}	9	43	9/29	24	199.03
G ^{1/2}	13	47	9/31	24	199.04

* union nut not removable

Thread	Hose LW	Dimensions [mm]			Order No.
		L	i	SW	

Parts for detachable hose tail

Hose plug with ball seal

Thread	Hose LW	Dimensions [mm]			Order No.
		L	i	SW	
G ^{1/8}	4	25	15	-	295-5
G ^{1/8}	6	25	15	-	295-6
G ^{1/4}	4	43,5	28	-	113-49
G ^{1/4}	6	37	25	-	106-16
G ^{1/4}	9	37	25	-	113-50
G ^{3/8}	4	47,5	31	-	120-10a
G ^{3/8}	6	39	25	-	113-38
G ^{3/8}	9	39	25	-	113-39
G ^{1/2}	6	41	25	-	113-47
G ^{1/2}	9	41	25	-	113-48
G ^{1/2}	13	45	36	-	113-45

Hexagon nut

Thread	Hose LW	Dimensions [mm]			Order No.
		L	i	SW	
G ^{1/8}	-	10	8	12	295-7
G ^{1/4}	-	14	11	17	124-19
G ^{3/8}	-	16	13	19	120-9
G ^{3/8} LH	-	16	13	19	124-18
G ^{1/2}	-	18	13	24	147-12

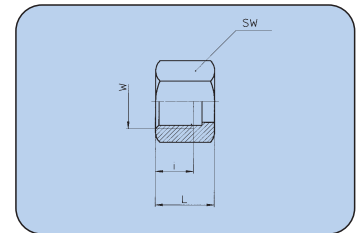
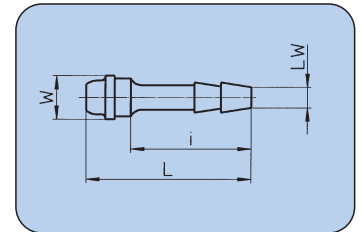
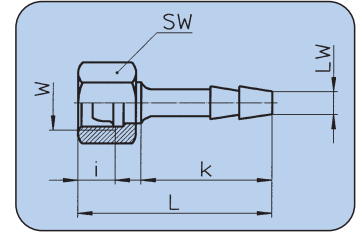
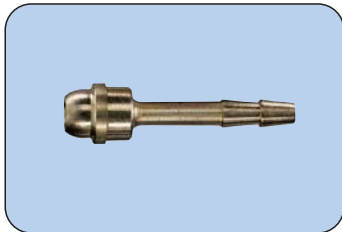
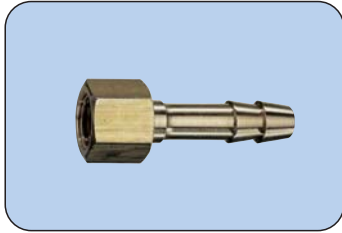

High Speed Connection Threaded Connections

Push in Fittings made out of plastic and brass (nickel plated). In connection with plastic (PU or PA) hoses applicable.

Technical Data

Application:	compressed air, vacuum, neutral gases
Material:	Plastic, Brass nickel plated
Max. pressure:	10bar
Recommended hose:	PU or PA (Nylon)*
Temperature range:	-20°C to +60°C
Seal:	NBR
Thread:	cylindrical with incorporated O-Ring

* Page 22

Thread	Hose øD	Dimensions [mm]			Order No.
		B	i	SW	

Straight Screwing In Link

with male thread

G ^{1/8}	4	19	6	10	582.1104
G ^{1/8}	6	21	6	14	582.1106
G ^{1/8}	8	26	6	14	582.1108
G ^{1/4}	4	18	8	14	582.1204
G ^{1/4}	6	23	8	14	582.1206
G ^{1/4}	8	25	8	14	582.1208
G ^{1/4}	10	31	8	17	582.1210
G ^{1/4}	12	34	8	21	582.1212
G ^{3/8}	6	21	9	17	582.1306
G ^{3/8}	8	22	9	17	582.1308
G ^{3/8}	10	28	9	17	582.1310
G ^{3/8}	12	28	8	21	582.1312
G ^{1/2}	6	25	11	21	582.1406
G ^{1/2}	8	26	11	21	582.1408
G ^{1/2}	10	26	11	21	582.1410
G ^{1/2}	12	33	11	21	582.1412

Straight Screwing On Plug Connection

with female thread

G ^{1/8}	4	23	8	10	582.2104
G ^{1/8}	6	24	8	12	582.2106
G ^{1/8}	8	26	8	14	582.2108
G ^{1/4}	4	26	11	14	582.2204
G ^{1/4}	6	27	11	14	582.2206
G ^{1/4}	8	29	11	14	582.2208
G ^{1/4}	10	32	11	17	582.2210
G ^{1/4}	12	34	11	21	582.2212
G ^{3/8}	6	28	12	17	582.2306
G ^{3/8}	8	30	12	17	582.2308
G ^{3/8}	10	33	12	17	582.2310
G ^{3/8}	12	35	12	21	582.2312
G ^{1/2}	6	30	14	21	582.2406
G ^{1/2}	8	32	14	21	582.2408
G ^{1/2}	10	35	14	21	582.2410
G ^{1/2}	12	37	14	21	582.2412

Bulkhead Union

Thread	Hose 2xøD	Dimensions [mm]		Order No.
		B	SW	
M12	4	30	14	582.9304
M14	6	32	17	582.9306
M16	8	35	19	582.9308
M20	10	42	24	582.9310
M22	12	45	27	582.9312

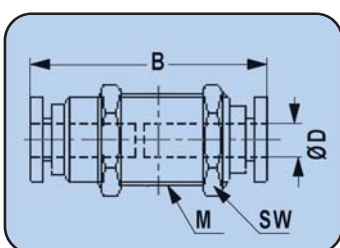
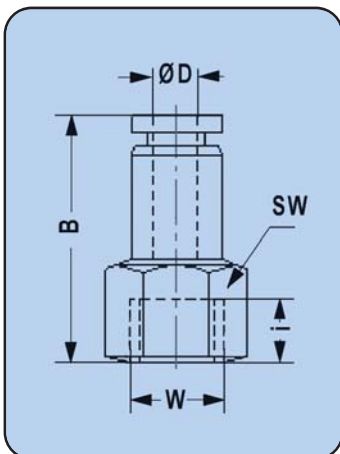
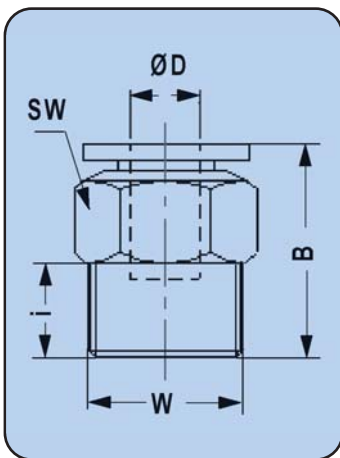

High Speed Connection Threaded Connections



Y-Connection

Thread	Hose W	Hose øD	Dimensions [mm]			SW	Order No.
			i	B	ød		
G ¹ / ₈	4	6	42	3	10	582.6104	
G ¹ / ₈	6	6	44	3	12	582.6106	
G ¹ / ₈	8	6	47	3	14	582.6108	
G ¹ / ₄	4	8	45	3	14	582.6204	
G ¹ / ₄	6	8	46	3	14	582.6206	
G ¹ / ₄	8	8	49	3	14	582.6208	
G ¹ / ₄	10	8	58	4	17	582.6210	
G ³ / ₈	6	9	48	3	17	582.6306	
G ³ / ₈	8	9	51	3	17	582.6308	
G ³ / ₈	10	9	59	4	17	582.6310	
G ¹ / ₂	6	11	51	3	21	582.6406	
G ¹ / ₂	8	11	54	3	21	582.6408	
G ¹ / ₂	10	11	63	4	21	582.6410	

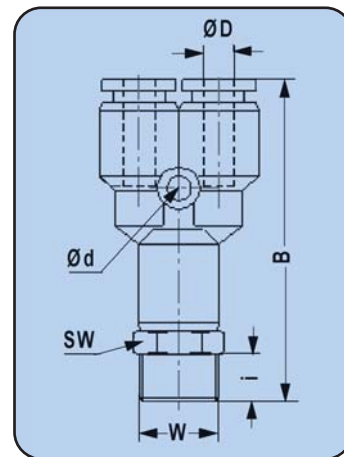

Screwing Angle male thread

Thread	Hose W	Hose øD	Dimensions [mm]			SW	Order No.
			i	B	E		
G ¹ / ₈	4	6	24	17	-	10	582.3104
G ¹ / ₈	6	6	26	19	3	12	582.3106
G ¹ / ₈	8	6	30	23	3	14	582.3108
G ¹ / ₄	4	8	27	18	-	14	582.3204
G ¹ / ₄	6	8	28	19	3	14	582.3206
G ¹ / ₄	8	8	32	23	3	14	582.3208
G ¹ / ₄	10	8	36	28	4	17	582.3210
G ¹ / ₄	12	8	39	30	4	21	582.3212
G ³ / ₈	6	9	30	19	3	17	582.3306
G ³ / ₈	8	9	33	23	3	17	582.3308
G ³ / ₈	10	9	37	28	4	17	582.3310
G ³ / ₈	12	9	40	30	4	21	582.3312
G ¹ / ₂	6	11	33	19	3	21	582.3406
G ¹ / ₂	8	11	37	23	3	21	582.3408
G ¹ / ₂	10	11	41	28	4	21	582.3410
G ¹ / ₂	12	11	43	30	4	21	582.3412

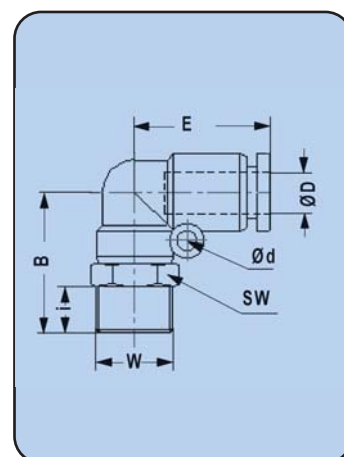

Screwed Angle Connection

Thread	Hose W	Hose øD	Dimensions [mm]			SW	Order No.
			i	B	E		
G ¹ / ₈	4	6	24	22	10	582.7104	
G ¹ / ₈	6	6	24	23	10	582.7106	
G ¹ / ₈	8	6	24	26	10	582.7108	
G ¹ / ₄	6	8	26	25	14	582.7206	
G ¹ / ₄	8	8	26	29	14	582.7208	
G ¹ / ₄	10	8	26	32	14	582.7210	
G ³ / ₈	6	8	32	27	19	582.7306	
G ³ / ₈	8	8	32	30	19	582.7308	
G ³ / ₈	10	8	32	33	14	582.7310	
G ³ / ₈	12	8	32	36	14	582.7312	
G ¹ / ₂	8	11	39	33	24	582.7408	
G ¹ / ₂	10	11	39	36	19	582.7410	
G ¹ / ₂	12	11	39	37	19	582.7412	

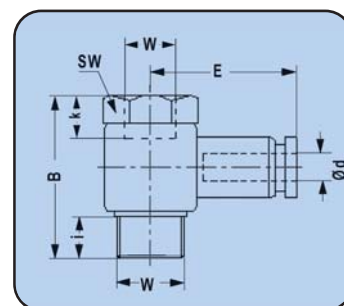

Distributor Plug In Connection with male thread, 3 tails reduced

Thread	Hose		Dimensions [mm]				SW	Order No.
	W	1xøD1 3xøD2	A	B	E	ød		
G ¹ / ₈	6	4	6	68	19	3	12	582.9851
G ¹ / ₄	8	4	8	71	20	2	14	582.9852
G ¹ / ₄	8	6	8	71	20	2	14	582.9853
G ³ / ₈	10	8	9	92	24	4	17	582.9854

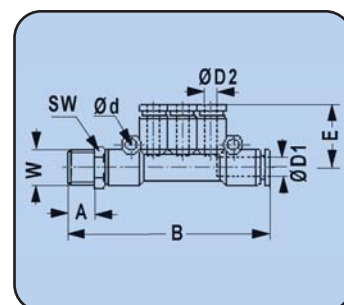

High Speed Connection Threaded Connections

T-Screwing in screw connection on side

Thread	Hose W	2x∅D	Dimensions [mm]				SW	Order No.
			i	B	E	∅d		
G ¹ / ₈	4	6	25	19	3	10	582.4104	
G ¹ / ₈	6	6	26	19	3	12	582.4106	
G ¹ / ₈	8	6	29	23	3	14	582.4108	
G ¹ / ₄	4	8	28	19	3	14	582.4204	
G ¹ / ₄	6	8	28	19	3	14	582.4206	
G ¹ / ₄	8	8	31	23	3	14	582.4208	
G ¹ / ₄	10	8	37	28	4	17	582.4210	
G ¹ / ₄	12	8	39	30	4	21	582.4212	
G ³ / ₈	6	9	30	19	3	17	582.4306	
G ³ / ₈	8	9	33	23	3	17	582.4308	
G ³ / ₈	10	9	38	28	4	17	582.4310	
G ³ / ₈	12	9	39	30	4	21	582.4312	
G ¹ / ₂	6	11	34	19	3	21	582.4406	
G ¹ / ₂	8	11	36	23	3	21	582.4408	
G ¹ / ₂	10	11	41	28	4	21	582.4410	
G ¹ / ₂	12	11	42	30	4	21	582.4412	



T-Screwing in screw connection

Thread	Hose W	2x∅D	Dimensions [mm]				SW	Order No.
			i	B	E	∅d		
G ¹ / ₈	4	6	25	18	3	10	582.5104	
G ¹ / ₈	6	6	26	19	3	12	582.5106	
G ¹ / ₈	8	6	29	23	3	14	582.5108	
G ¹ / ₄	4	8	28	18	3	14	582.5204	
G ¹ / ₄	6	8	29	19	3	14	582.5206	
G ¹ / ₄	8	8	31	23	3	14	582.5208	
G ¹ / ₄	10	8	37	28	4	17	582.5210	
G ¹ / ₄	12	8	38	30	4	21	582.5212	
G ³ / ₈	6	9	30	19	3	17	582.5306	
G ³ / ₈	8	9	33	23	3	17	582.5308	
G ³ / ₈	10	9	38	28	4	17	582.5310	
G ³ / ₈	12	9	40	30	4	21	582.5312	
G ¹ / ₂	6	11	34	19	3	21	582.5406	
G ¹ / ₂	8	11	36	23	3	21	582.5408	
G ¹ / ₂	10	11	41	28	4	21	582.5410	
G ¹ / ₂	12	11	42	30	4	21	582.5412	



T-Connection

Hose 3x ∅D	Dimensions [mm]		Order No.
	E	∅d	
4	18	3	582.9204
6	19	3	582.9206
8	23	3	582.9208
10	28	4	582.9210
12	30	4	582.9212



T-Connection reduced

Hose ∅D1 ∅D2	Dimensions [mm]		Order No.
	E	∅d	
6 4	19	3	582.9811
8 6	23	3	582.9812
10 8	28	4	582.9813
12 10	30	4	582.9814

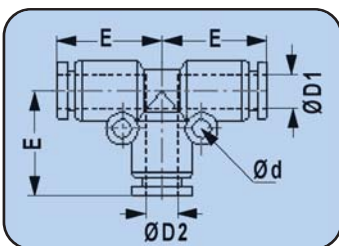
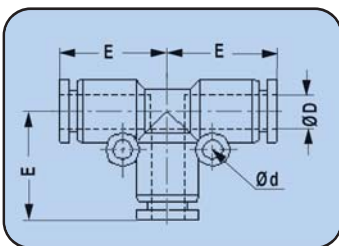
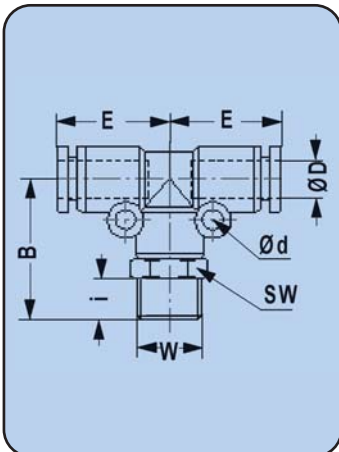
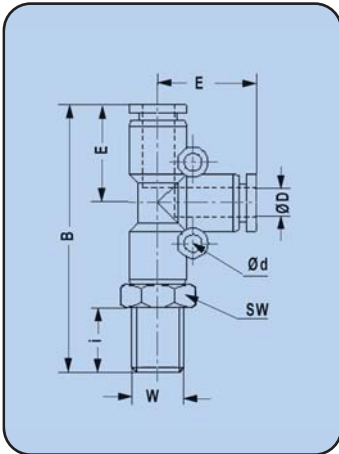

High Speed Connection

Threaded Connections



Straight Connection

Hose 2x $\varnothing D$	Dimensions [mm] B	Order No.
4	33	582.9004
6	35	582.9006
8	39	582.9008
10	48	582.9010
12	49	582.9012

Straight Connection reduced

Hose $\varnothing D1$ $\varnothing D2$	Dimensions [mm] B	Order No.
6 4	35	582.9801
8 6	39	582.9802
10 8	47	582.9803
12 10	49	582.9804

Angle Connection

Hose 2x $\varnothing D$	Dimensions [mm]		Order No.
	E	$\varnothing d$	
4	18	-	582.9104
6	19	3	582.9106
8	23	3	582.9108
10	28	4	582.9110
12	30	4	582.9112

Cross Connection

Hose $\varnothing D$	Dimensions [mm]	Order No.	
	E	$\varnothing d$	
4	18	3	582.9404
6	19	3	582.9406
8	23	3	582.9408
10	28	4	582.9410
12	30	4	582.9412

Y-Connection

Hose 3x $\varnothing D$	Dimensions [mm]	Order No.	
	B	$\varnothing d$	
4	36	3	582.9504
6	37	3	582.9506
8	40	3	582.9508
10	50	4	582.9510
12	53	4	582.9512

Y-Connection reduced

Hose $\varnothing D1$ $\varnothing D2$	Dimensions [mm]	Order No.	
	B	$\varnothing d$	
6 4	37	3	582.9821
8 6	40	3	582.9822
10 8	49	3	582.9823
12 10	53	4	582.9824

Y-Connection with plug nipple

Hose 2+1 $\varnothing D$	Dimensions [mm]	Order No.	
	B	$\varnothing d$	
4	51	3	582.9604
6	55	3	582.9606
8	60	3	582.9608
10	73	4	582.9610
12	78	4	582.9612

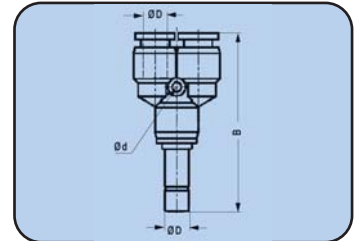
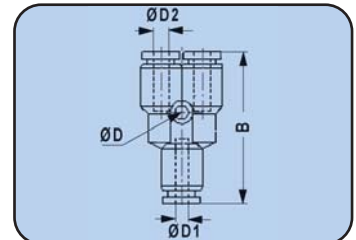
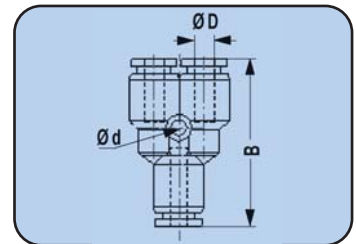
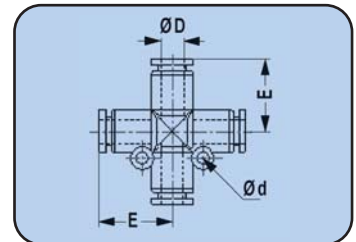
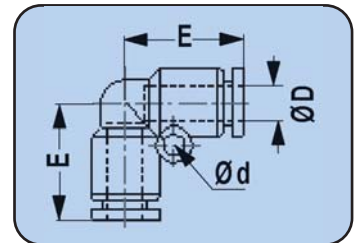
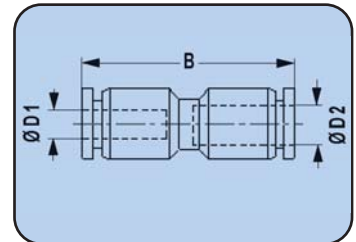
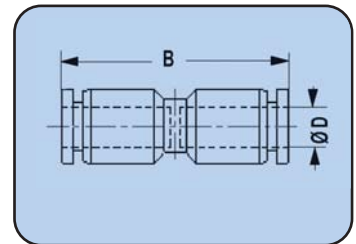

High Speed Connection Threaded Connections

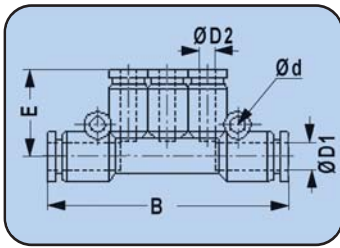

Distributor Plug In

Connection for Pipe

Hose 2x ØD1	Hose 3x ØD2	Dimensions [mm]			Order No.
		B	E	Ød	
6	4	58	19	3	582.9841
8	4	63	20	3	582.9842
8	6	63	20	3	582.9843
10	6	77	24	4	582.9844
10	8	77	24	4	582.9845

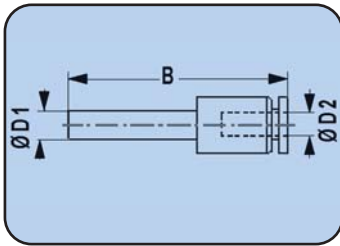

Straight Plug reduced

Hose ØD2	Hose ØD1	Dimensions [mm]	Order No.
		B	
4	6	42	582.9831
4	8	44	582.9832
6	8	45	582.9833
6	10	47	582.9834
8	10	47	582.9835
6	12	54	582.9836
8	12	54	582.9837
10	12	55	582.9838

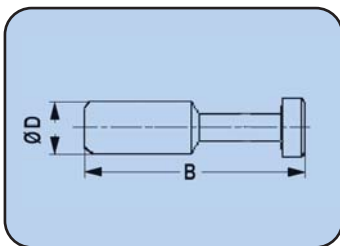

Catch Plug

Hose ØD	Dimensions [mm] B	Order No.
4	28	582.9861
6	33	582.9862
8	37	582.9863
10	42	582.9864
12	44	582.9865

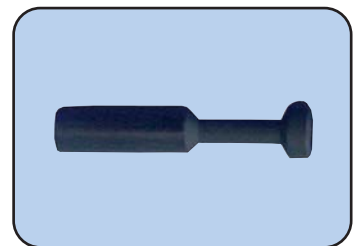

Plastic Hose for High Speed Connections Hoses



Polyurethane-Hose (PU)

Polyurethane tubes are extremely flexible and very kink resistant with small bend for routing into tight places. The excellent memory tolerates repeated flexing. It is also very abrasion resistant and outlast other tubings. Good resistance against mineral oil, lubrication grease, oxygen, ozone and aliphatic hydrocarbons. The ideal choice for fluid power applications together with **High Speed Connections** (see page 21-26)

Hose Dxd	Pressure [bar]	Color	Order No.
4x2,5	11	blue	582.004
6x4,0	11	blue	582.006
8x5,5	11	blue	582.008
10x6,5	11	blue	582.010
12x8,0	11	blue	582.012

Minimum tax: 10m (10m steps)

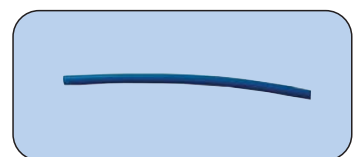

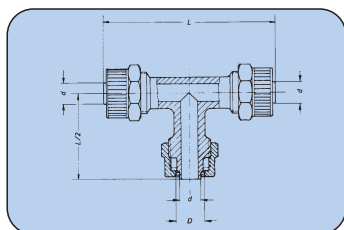
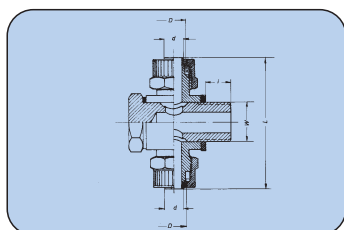
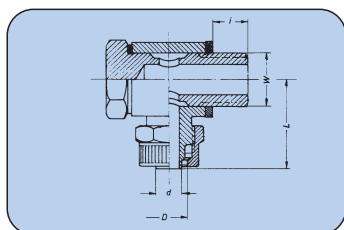
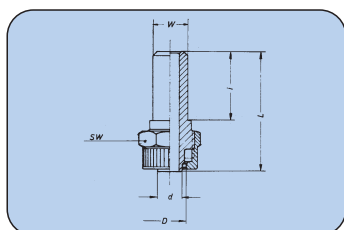
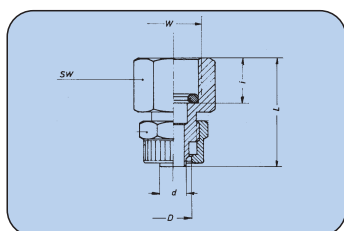
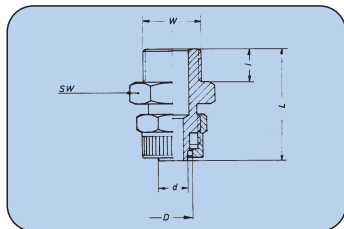
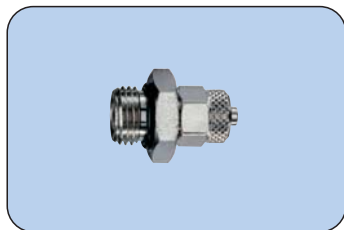

or rapid connection of plastic hoses with connector threads. The hose is pushed over the corresponding plug and clamped securely with the swivel nut. The swivel nut is knurled so that it can be tightened quickly and has a hexagon screw to secure the connection. Hoses with an inner diameter of 4, 6 and 8 mm. Port sizes G¹/₈, G¹/₄ and G³/₈.

Thread	Hose D x d	Dimensions [mm]			Order No.
		L	i	SW	

Straight Male Screw-In Connector

G ¹ / ₈	6 x 4	25	6	15	401.112
G ¹ / ₈	8 x 6	25	6	15	401.113
G ¹ / ₄	6 x 4	27	8	18	401.122
G ¹ / ₄	8 x 6	27	8	18	401.123
G ¹ / ₄	10 x 8	29	8	18	401.124
G ³ / ₈	8 x 6	29	9	21	401.133
G ³ / ₈	10 x 8	31	3	21	401.134

Straight Female Screw-On Connector

G ¹ / ₄	6 x 4	28	8	17	401.222
G ¹ / ₄	8 x 6	28	8	17	401.223

Bulkhead Stuffing Boxes

ø 6	6 x 4	28	15	12	401.302
ø 9	8 x 6	31	18	14	401.303

Bulkhead Stuffing Boxes

M10x1	6 x 4	47	11	14	401.402
M12x1	8 x 6	48	13	16	401.403

Swivel Elbow Connector

G ¹ / ₈	6 x 4	25	9	401.512
G ¹ / ₈	8 x 6	25	9	401.513
G ¹ / ₄	6 x 4	25	11	401.522
G ¹ / ₄	8 x 6	25	11	401.523
G ¹ / ₄	10 x 8	30	11	401.524

Swivel T-Connector

G ¹ / ₈	6 x 4	48	6	401.612
G ¹ / ₈	8 x 6	48	6	401.613
G ¹ / ₄	6 x 4	53	8	401.622
G ¹ / ₄	8 x 6	52	8	401.623
G ¹ / ₄	10 x 8	55	8	401.624

T-Distributor

-	6 x 4	44	401.702
-	8 x 6	44	401.703

4-Way Distributor

-	6 x 4	42	401.802
-	8 x 6	45	401.803

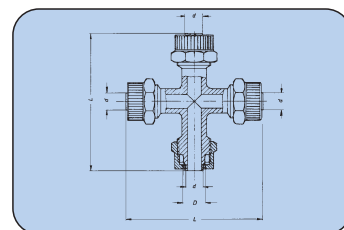
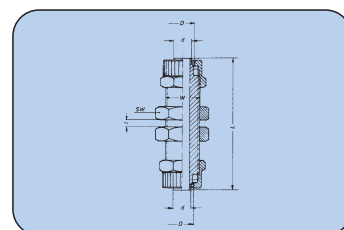

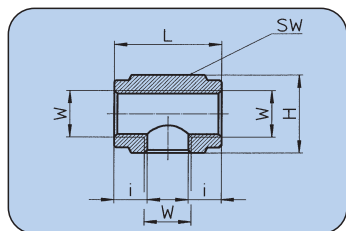

Hose	Dimensions [mm]					Order No.
	W	L	H	i	SW	

T-Distributor

G ¹ / ₈	23	-	6	17	401-39
G ¹ / ₄	30	22	8	22	401-40

Double Nipple

G ¹ / ₈	19	-	7	17	185.029
G ¹ / ₄	22	-	8,5	21	185.033

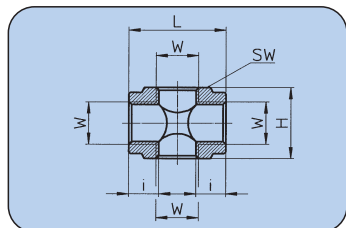
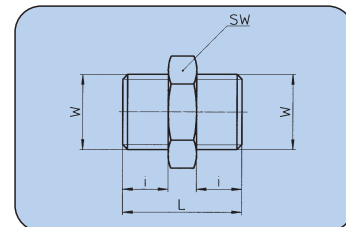

4-Way Distributor

G ¹ / ₈	23	-	6	17	401-41
G ¹ / ₄	30	22	8	22	401-42

Screw-On Distributor L

G ¹ / ₈	-	22	7	14	401-43
G ¹ / ₄	22	29	10	22	401-44

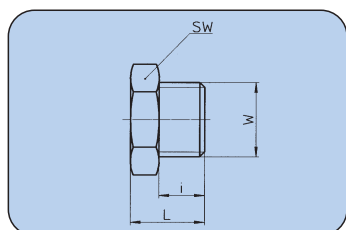
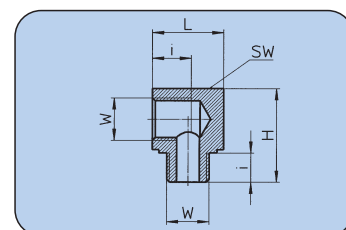

Screw Plug

G ¹ / ₈	11	-	6	14	401-47
G ¹ / ₄	13	-	8	17	401-48
G ³ / ₈	14	-	8	19	401-55
G ¹ / ₂	16	-	10	24	401-56

Screw-On Distributor T

G ¹ / ₈	-	22	8	17	401-45
G ¹ / ₄	-	29	10	22	401-46

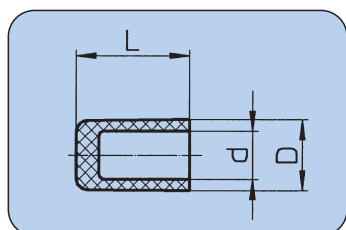
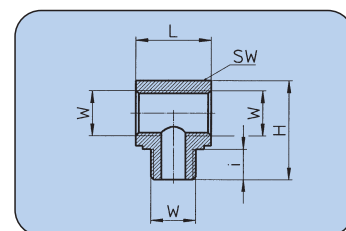

Plug PA 11

6 x 4	10	401-1
8 x 6	14	401-2
10 x 8	18	401-3

Dimensions [mm]		Order No.
D x d	i	

Thread	Dimensions [mm]			Order No.
	W	D	d	

Sealing Ring Of PVC

G ¹ / ₈	13,9	9,8	1,5	289-133
G ¹ / ₄	16,5	13,2	1,5	269-97

Sealing Ring PA Undetachably

G ¹ / ₈	320-35
G ¹ / ₄	308-124
G ³ / ₈	308-125

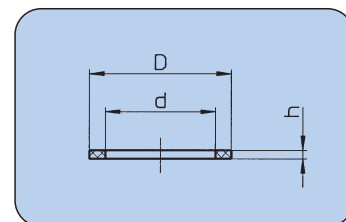

Technical Data

Max. operating pressure (PN)	40 bar
Operating temperature	-10 °C up to +90 °C
Mounting position	any
Direction of flow	any
Material	brass

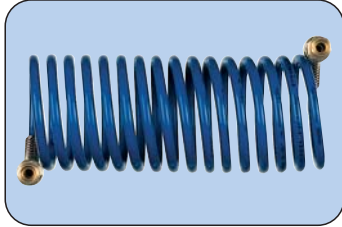

Spiral Hose Polyamide (PA)

Spiral hoses with complete connections at both ends and with anti knik device. Hose of polyamide 11 (PA) blue. Maximum working length approx. 80% of the overall length. Non-kinking, resistant to reduction of inside diameter.

Hose D x d	Overall Length m	ø outside mm	Thread	Order No.
6 x 4	2,5	75	G ¹ / ₄	580.221
8 x 6	2,5	75	G ¹ / ₄	580.321
8 x 6	5,0	75	G ¹ / ₄	580.322
8 x 6	7,5	75	G ¹ / ₄	580.323
10 x 8	2,5	115	G ¹ / ₄	580.521
10 x 8	5,0	115	G ¹ / ₄	580.522
10 x 8	7,5	115	G ¹ / ₄	580.523
12 x 9	5,0	140	G ³ / ₈	580.432
12 x 9	7,5	140	G ³ / ₈	580.433

Mounting with brass Couplings and Plugs DN7,2

8 x 6	5,0	75	-	473.1
8 x 6	7,5	75	-	473.2
12 x 9	5,0	140	-	473.3
12 x 9	7,5	140	-	473.4

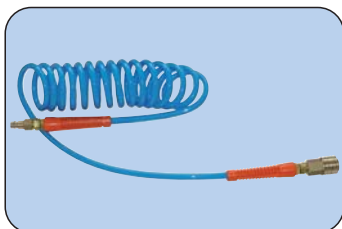
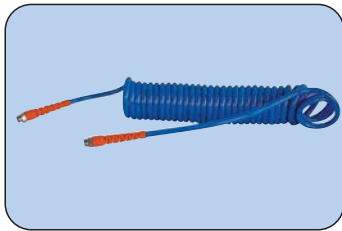

Spiral Hose Polyurethane (PU)

With complete connections at both ends, maximum working length approx. 60% of the overall length, non-kinking, less rubbing off than polyamide hoses, soft surface less scratching-danger of sensitive surfaces.

Hose D x d	Overall Length m	ø outside mm	Thread	Order No.
8 x 5	3,0	40	G ¹ / ₄	580.125
8 x 5	6,0	40	G ¹ / ₄	580.126
8 x 5	7,5	40	G ¹ / ₄	580.127
9,5 x 6,3	3,5	60	G ¹ / ₄	580.225
9,5 x 6,3	6,0	60	G ¹ / ₄	580.226
9,5 x 6,3	7,5	60	G ¹ / ₄	580.227
12 x 8	3,5	80	G ³ / ₈	580.435
12 x 8	6,0	80	G ³ / ₈	580.436
12 x 8	7,5	80	G ³ / ₈	580.437

Mounting with brass Couplings and Plugs DN7,2

9,5 x 6,3	6,0	60	-	473.5
9,5 x 6,3	7,5	60	-	473.6
12 x 8	6,0	80	-	473.7
12 x 8	7,5	80	-	473.8

Technical Data

Max. operating pressure at

+20 °C - 12 bar
+40 °C - 10 bar
+60 °C - 8 bar
+80 °C - 6 bar

Operating temperature

0 °C to +100 °C

Technical Data

Max. operating pressure

8 bar at max. 50 °C

Operating temperature

-40 °C to +85 °C

Colour

blue

Maximum working length

approx. 60% of the overall length

Technical Data

Max. operating pressure at

- +20°C - 12 bar
- +40°C - 10 bar
- +60°C - 8 bar
- +80°C - 6 bar

Operating temperature

-40°C to + 100°C

Option

Cut goods without connectors on request

Technical Data

Max. operating pressure

8 bar at max. 50°C

Operating temperature

-40°C to +85°C

Colour

blue

Maximum working length

approx. 60% of the overall length

Spiral Hose Polyamide (PA)

Spiral hoses with complete connections at both ends and with anti kink device. Hose of polyamide 12 (PA) blue. Maximum working length approx. 60% of the overall length. Non-kinking, resistant to reduction of inside diameter

Hose D x d	Overall Length [m]	ø outside [mm]	Thread	Order No.
6 x 4	2,5	62	G 1/4	580.241
8 x 6	2,5	91	G 1/4	580.341
8 x 6	5	91	G 1/4	580.342
8 x 6	7,5	91	G 1/4	580.343
8 x 6	10	91	G 1/4	580.344
8 x 6	30	91	G 1/4	580.345

Mounting with brass Couplings and Plugs DN7,2

Hose D x d	Overall Length [m]	ø outside [mm]	Thread	Order No.
6 x 4	2,5	62	-	473.241
8 x 6	2,5	91	-	473.341
8 x 6	5	91	-	473.342
8 x 6	7,5	91	-	473.343
8 x 6	10	91	-	473.344
8 x 6	30	91	-	473.345

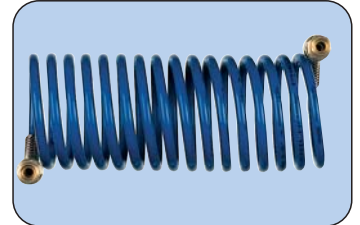

Spiral Hose Polyurethane (PU)

With complete connections at both ends, maximum working length approx. 60% of the overall length, non-kinking, less rubbing off than polyamide hoses, soft surface less scratching-danger of sensitive surfaces.

Hose D x d	Overall Length [m]	ø outside [mm]	Thread	Order No.
10x6,5	3,5	69	G 1/4	580.245
10x6,5	6	69	G 1/4	580.246
10x6,5	7,5	69	G 1/4	580.247
10x6,5	10	69	G 1/4	580.248

Mounting with brass Couplings and Plugs DN 7,2

Hose D x d	Overall Length [m]	ø outside [mm]	Thread	Order No.
10x6,5	3,5	69	-	473.245
10x6,5	6	69	-	473.246
10x6,5	7,5	69	-	473.247
10x6,5	10	69	-	473.248

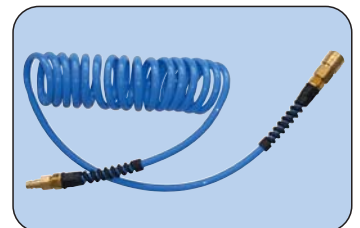

Rotating Screw

with bend protection spring

Hose D x d	Thread	SW	Order No.
6 x 4	G 1/4	14	474-1
8 x 5	G 1/4	14	474-2
8 x 6	G 1/4	14	474-3
9,5 x 6,3	G 1/4	15,8	474-4
10 x 6,5	G 1/4	15,8	474-5
10 x 8	G 1/4	15,8	474-6
12 x 8	G 1/4	17	474-7

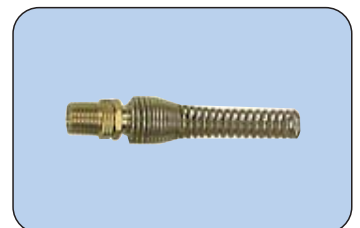

Hose Reels / Plastic Hoses

Hoses



Hose Reel

Automatic runback interlock clear and simple circuit. PU hose suitable for air and water. Resistant to 40°C. Closed plastic housing (shock) inside and outside use. Pivoting bracket made of steel for wall and ceiling mounting.

Hose DN	Lenght [m]	Pressure [bar]	Connection	Order No.
8mm	12	10	G ¹ / ₄	477-36

Dimensions l x w x h [mm]: 360 x 330 x 210

Weight [kg]: 4,5

10mm	14+1	15	G ³ / ₈	477-38
------	------	----	-------------------------------	---------------

Dimensions l x w x h [mm]: 420 x 390 x 230

Weight [kg]: 5,9



PVC Hose converted for compressed air mounted with brass couplings and plugs DN7,2.

PVC fabric hose with inlay, water-clear, conditionally oil-, gasoline- and base-resistant. Standard hose for a wide range of applications in industry, machine and plant construction, manual trades and laboratories. PVC hoses are resistant to pressure, UV and ageing with an unlimited storage life. If they are used with flowing oils, the softener contained in the PVC is removed, as a result the hose loses its UV resistance and gets brittle.

D x d [mm]	Pressure [bar]	Lenght [m]	Order No.
12 x 6	15	5	E40200
		10	E40201
		20	E40203
		30	E40205
		40	E40208
15 x 8	15	50	E40209
		5	E40210
		10	E40211
		20	E40213
		30	E40215
20 x 13	10	40	E40217
		50	E40219
		5	E40250
		10	E40251
		20	E40253
		30	E40255
		40	E40257
		50	E40259

50 m roll without connections (coupling and plug)

12 x 6	15	50	E40013
15 x 9	15	50	E40014
20 x 13	10	50	E40015
26 x 19	10	50	E40019
34 x 25	8	50	E40020

Technical Data

Operation temperature:

compressed air: -40°C to +80°C
water: to +40°C

Operating pressure:

10 bar (477-36)
15 bar (477-38)

Tubing:

PU with PE fabric, glossy, blue, with bend protection spring

Housing material:

plastic, blue

Bracket:

steel, swivel

Locking:

disengaged

Technical Data

Temperature range:

-20°C to +60°C

Operating pressure at 20°C:

see in table

Soul:

PVC, water-clear

Pressure carrier:

high-strength synthetic textile strings

Cover:

PVC, water-clear, flexible, plane

Hoses

Technical Data

Temperature range:

 compressed air: -20°C to +70°C
 water: to +90°C

Cracking pressure:

>40 bar

Soul:

PVC, black, plane

Pressure carrier:

coiled, synthetic textile strings

Cover:

black, plane, abrasion-resistant and weather-proof

Length of reel:

50m

PVC Hose for compressed air

in extruded version. According to DIN20018 for rough conditions of use. Resistant against water- and mineral oil-containing compressed air. Flexible, non-bending, abrasion-resistant and weather-proof.

O.D. x I.D.	P at 20°C [bar]	Order No.
14 x 5	25	502.31
12 x 6	15	502.32
15 x 9	12	502.33
20 x 13	8	502.34



Technical Data

Silicon-free
Operating temperature:

-25°C to +80°C

Cracking pressure:

64 bar

Soul:

SBR blend, flameproof fabric insert from PVAA

Cover:

SBR/EPDM-blend, black/blue with labeling

Length of reel:

40m (can vary by up to 10%)

Rubber Hose for compressed air blue stripes

The ideal workshop compressed air hose (ISO 2398, Cat 4B) has a soul of a SBR compound and is resistant to weathering and oil-containing compressed air. He is very flexible, black, smooth, and has blue stripes.

O.D. x I.D.	P at 20°C [bar]	length	Order No.
40m roll without connections			
13 x 6	16		E40401
16,5 x 9,5	16		E40402
21 x 13	16		E40403
29 x 19	16		E40404
37 x 25	16		E40405

with High Flow coupling DN7,4 and plug DN7,2 (steel) mounted

16,5 x 9,5	16	5m	E40420-5
16,5 x 9,5	16	10m	E40420-10



Technical Data

Silicon-free
Operating temperature:

-20°C to +90°C

Cracking pressure:

64 bar

Soul:

Antistatic flexible PVC inner core, Soft PVC layer, Polyester reinforcement

Cover:

Matt Blue, oil resistant

Length of reel:

40m

Painting and Air Hose

with coupling and connector mounted DN 7.2 (brass)

This hose is designed for extreme conditions and consists of three-layer thermoplastic. It is reinforced with a fabric insert in polyester fibers. The hose cover protects against oil, grease, paint and hydrocarbons. It also provides the ability to derive electrostatic voltages.

Typical applications include repair shops, paint shops, automotive, plastics processing, assembly plants and carpentry.

O.D. x I.D.	P at 20°C [bar]	length	Order No.
40 m roll without connections			
16 x 9	16	40m	E40502
with coupling and plug DN7,2 (brass) mounted			
16 x 9	16	8m	E40500
16 x 9	16	10m	E40510





Plastic Hoses

Plastic Hose

without reinforcement
Roll length: 50/100m
Material: polyethylene, polyamide 11

Hoses	P at 20°C	P at 40°C	P at 60°C	Bestell-Nr.:
O.D x I.D.				

Polyethylene-Hose

flexible, transparent

6 x 4	10	5	-	E40350
8 x 6	8	4	-	E40351
10 x 8	6	3	-	E40353
12 x 9	8	4	-	E40352

Polyamide-11-Hose

flexible, natural colour, transparent

6 x 4	27	18	15	E40362
8 x 6	19	13	11	E40361
10 x 8	12,5	9	7	E40363
12 x 9	16	11	9	E40360



Technical Data

Max. operating pressure
see under 20°C, 40°C, 60°C
in table

Operating temperature
PE 0°C to + 80°C
PA11 0°C to +100°C



Strainers

Hoses

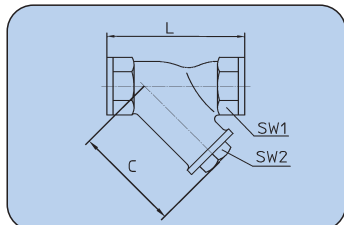

Strainers

tombac

For liquids, gases, steam, water, mineral oils, heating oils and hydraulic oils, fuels, and other non-aggressive media in liquid and gaseous states.

Thread	DN	C	L	SW1	SW2	Order No.
G ¹ / ₄	8	35	43,0	18,0	13	397.022
G ³ / ₈	10	39	49,0	22,0	14	397.023
G ¹ / ₂	15	46	55,5	25,5	21	397.024
G ³ / ₄	20	57	70,0	32,5	24	397.025
G1	25	62	82,0	38,5	32	397.026
G1 ¹ / ₄	32	73	90,0	48,5	35	397.027
G1 ¹ / ₂	40	87	101,0	55,0	39	397.028
G2	50	102	123,5	66,0	45	397.029

Technical Data

Operating pressure:
max. 10bar

Operating temperature:
max. 110°C

Material:

Housing brass
Headpiece brass
Sieve Double sieve for Stainless steel mesh for fine filtration 0,2mm

Accessories

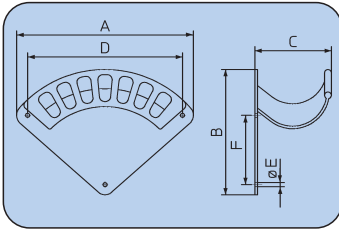

Garage-wall holder

Light-alloy casting (in one piece cast).
Extreme stable, solid construction and manufacture.

Size	Dimensions [mm]						Order No.
	A	B	C	D	E	F	
I	188	147	70	150	6	78	E42070
II	266	201	108	225	6	107	E42072
III	348	257	144	170	8	136	E42071



Teflon sealing band

DVGW approved and BAM tested

Fine thread FRp 12m, 60g/m ²	E63199
Thickness: 0,10mm, width: 12mm	
Coarse thread GRp 12m, 100g/m ²	E63198
Thickness: 0,10mm, width: 12mm	
temperature range -20°C to +125°C	

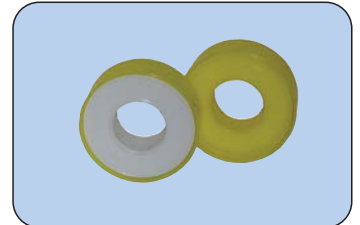

Special Air Oil

Compressed air special oil for lubricators and maintenance units according to DIN51524-2 with viscosity class VG32 according to ISO3448 (viscosity at 40°C - 32mm²/s; 32 cSt). The oil contains surface active substances, which provide corrosion protection over a large temperature range. It also takes up condensation water (demulsifying). The 1-litre polyethylene bottle with volume scale has a practical filling hose, which can be pulled out after unscrewing the sealing cap.

Volume 1 litre	583
Volume 5 litre	583.1
temperature range -20°C to +80°C	



Compressor-Oil ISO 150DD, DIN51506

Air compressor oil for piston compressores according to DIN510506 for compressor temperatures up to 220°C. This oil, based on mineral oil with a powerful dispersion and detergency capability prevents depositing of aging products and foreign objects. This has a strong resistance against corrosion through its condensed water absorbing qualities (demulsifying). Its positive resistance against oxidation provides safety against explosions.

Volume 1 litre	583.10
----------------	---------------



Ball Valve

Valves (heavy duty version)

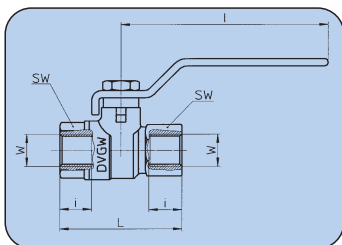
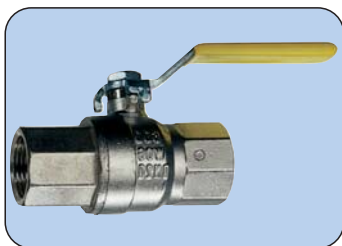
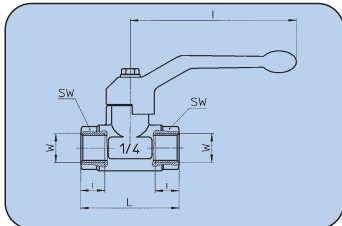

Compact Ball Valve

Ball valves of nickel-plated brass with a chromium-plated ball. Seals of Teflon (PTFE and NBR). Metal lever (alu alloy). Straight-through opening same as port size.

Thread	Dimensions [mm]					Order No.
	W	DN	L	i	SW	

female thread

G ^{1/4}	8	44,4	10	25	80	569.202
G ^{3/8}	10	44,4	10	25	80	569.204
G ^{1/2}	15	50,5	12,5	31	80	569.206
G ^{3/4}	20	57,5	13,5	37	113	569.208
G1	25	70	15	38	113	569.209
G1 ^{1/4}	32	80,5	16,5	47	138	569.210
G1 ^{1/2}	40	94,5	17,5	54	138	569.211
G2	50	112,5	20,5	66	158	569.212

with female - male thread

G ^{1/4}	8	54	10,5	25	80	569.502
G ^{3/8}	10	54	10,5	25	80	569.504
G ^{1/2}	15	58,5	11,5	31	80	569.506
G ^{3/4}	20	66,5	13,5	37	113	569.508
G1	25	78,5	14,5	38	113	569.509
G1 ^{1/4}	32	91,5	17	47	138	569.510
G1 ^{1/2}	40	105,5	19	54	138	569.511
G2	50	122	21	66	158	569.512

Ball Valve with DVGW-Approval (EN331)

Ball Valves of nickel-plated brass with a chromium-plated ball. Seals of Teflon (PTFE and NBR). Metal lever (steel). Straight-through opening same as port size.

Thread	Dimensions [mm]					Order No.
	W	DN	L	i	SW	

female thread

G ^{1/4}	8	49	13	18	80	574.202
G ^{3/8}	10	52	13	21	80	574.204
G ^{1/2}	15	61	16	25	89	574.206
G ^{3/4}	20	68	17	31	113	574.208
G1	25	85	20	38	113	574.209
G1 ^{1/4}	32	99	20	47	138	574.210
G1 ^{1/2}	40	109	22	54	160	574.211
G2	50	130	24	66	160	574.212

with female - male thread

G ^{1/4}	8	57	13	18	80	574.502
G ^{3/8}	10	59	13	21	80	574.504
G ^{1/2}	15	68	15	25	88	574.506
G ^{3/4}	20	75	17	31	113	574.508
G1	25	90	18	38	113	574.509
G1 ^{1/4}	32	105	20	47	137	574.510
G1 ^{1/2}	40	115	25	54	157	574.511
G2	50	135	25	66	157	574.512

Technical Data

Max operation pressure:

G ^{1/4} - G ^{1/2}	50 bar
G ^{3/4} - G1	40 bar
G1 ^{1/4} - G1 ^{1/2}	30 bar
G2	25 bar

Operation temperatur:

-40°C bis +200°C (PTFE Seal)

Sealing:

ball-seal: PTFE
spindle-seal: Viton

Permissible Media:

non-flammable and non-poisonous gases and liquids

Mounting position:

any

Direction of flow:

any

Marked with identification according to AD info-sheet A4

Technical Data

Max. operation pressure:

5 bar (MOP5, PN16 for compressed air)

operation temperatur:

-10°C bis +80°C (PTFE Seal)

Sealing:

ball-seal: PTFE
spindle-seal: Viton

Permissible Media:

Flammable gases, except acetylene and hydrogen

Mounting position:

any

Direction of flow:

any

Marked with identification according to DVGW



Shut-Off and Regulating Valve Valves



Shut-off valves are 2-way valves with manual operation. The seal is carried out by a stainless steel ball. Spindle seal is made by an o-ring of perbunan.

Needle regulating valves seal by means of a brass cone, thus allowing continuous regulation between "on" and "off" (open and closed).

Thread	Dimensions [mm]					Order No.
	W	DN	L	i	H	

Shut-Off Valve

straight through type, with male thread

G ¹ / ₈	3,5	35	7	30	22	296.01
G ¹ / ₄	3,5	34	8	30	22	296.11
G ¹ / ₄	6	43	10	50	48	556.12
G ³ / ₈	10	52	12	50	48	556.14
G ¹ / ₂	10	64	14	54	48	556.16

Shut-Off Valve

straight through type, with female thread

G ¹ / ₄	6	43	11	50	48	556.22
G ³ / ₈	9	52	12	50	48	556.24
G ¹ / ₂	11	63	15	57	48	556.26

Shut-Off Valve

elbow type, with male thread

G ¹ / ₈	3,5	34	7	26	22	295.01
G ¹ / ₄	3,5	34	8	26	22	295.11

Needle Regulating Valve

straight through type, with male thread

G ¹ / ₄	4	42	11	52	50	558.12
G ³ / ₈	4	42	11	52	50	558.14
G ¹ / ₂	11	65	15	60	50	558.16

Needle Regulating Valve

straight through type, with female thread

G ¹ / ₄	4	42	12	50	50	558.22
G ³ / ₈	4	51	13	50	50	558.24
G ¹ / ₂	11	64	15	50	50	558.26

Technical Data

Max. operating pressure	25 bar (PN25) for DN3,5 40 bar (PN40) from DN5,5
Operating temperature	-10°C to +90°C
Permissible Media	non-flammable and non-poisonous gases. Preferably air
Mounting position	any
Direction of flow	arrow
Material	brass
Handwheel (556.xx + 558.xx)	plastic

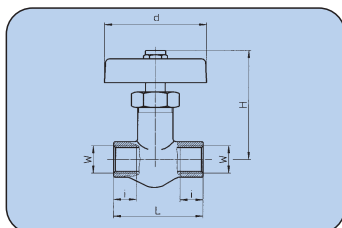
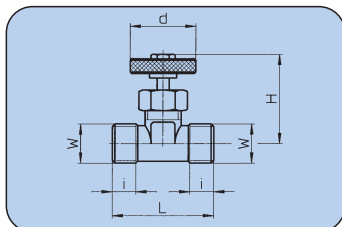
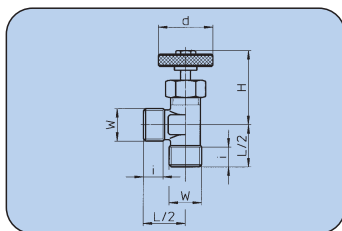
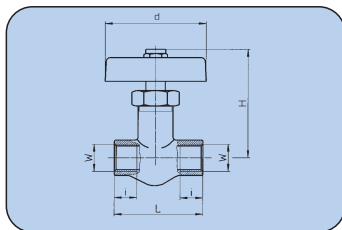
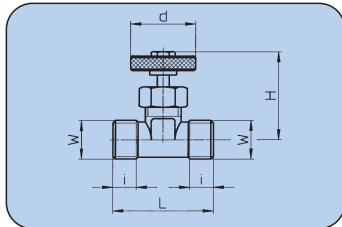

ewo

Drain Valve

Valves



Drain valves of brass, straight or elbow-type, originally served to let out the condensation at the lowest point of compression tank. Today they are generally used for air exhaust. Soft seal (NBR) with handwheel, metal seal equipped with toggle.

Thread W	Dimensions [mm]					Order No.
	DN	L	i	d	SW	

Drain Valves with brass handwheel

elbow type,
with soft seal

G ¹ / ₈	5	43	9	20	-	166.02
G ¹ / ₄	5	43	12	20	-	166.12

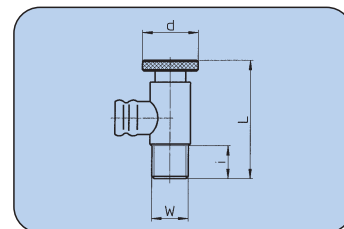

Drain Valves

straight type,
with metal seal

G ¹ / ₈	5	35	7	40	12	212.01
G ¹ / ₄	5	35	10	42	14	168.11

nickel-plated

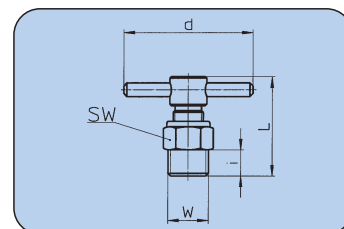

Technical Data

Max. operating pressure	25 bar (PN25)
Operating temperature	0°C up to +90°C
Mounting position	any

ewo

Air Distributor

Valves



Air distributors make it possible to have two or three taps that can be shut off individually. They are constructed either of hot-pressed brass with two outlets or of fittings that have two or three diaphragm shut-off valves. (See also air distributors with couplings).

Thread W	Dimensions [mm]						Order No.
	DN	L	i	H	d		

Air Distributors

of hot-pressed brass, metal handwheel, 2-way,
with hose tails, dispatch oblique

G ¹ / ₄	6mm	6	79	9	110	25	559.621
G ³ / ₈	9mm	6	79	9	110	25	559.631

without hose tails

G ¹ / ₄	6	79	9	65	25	559.121
G ³ / ₈	6	79	9	65	25	559.131

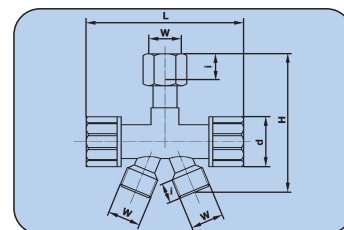

Technical Data

Max. operating pressure	40 bar (PN40)
Operating temperature	-10°C up to +90°C
Mounting position	any



Manual Slide Valve (3/2-Way Valve)



Valves

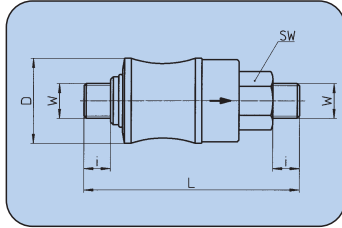

Manual slide valves are ideal fittings for equipment which, when turned off, must as a safety measure also be relieved; for example, **putty-applicators, clamp-cylinders, nail-drivers, grinders, drills, screw drivers etc.** When the compressed air pressure is escaped accidental operation cannot cause any injuries or damage. The manual slide valves can be connected to the compressed air system with ²/₃ hose connectors or quick detachable connectors for plastic hoses. The desired individual parts can be found in the catalogue.

Operation
3 ways 2 switch-positions, operation by axial movement of the slide.

Protective device: The slide is elongated on the outer side in order to prevent the fingers from getting caught during operation.

Safe relieving of compressed air: Compressed air that escapes during exhaust is directed safely in axial direction.

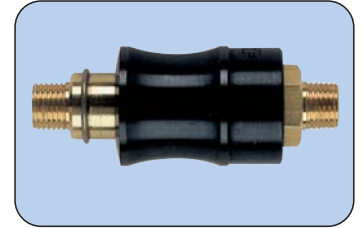

Thread	Dimensions [mm]				Order No.
W	D	L	i	SW	

Manual Slide Valves (2/3 Way Valves)

G ¹ / ₈	26	72	8	14	321.11
G ¹ / ₄	32	81	10	19	321.12
G ³ / ₈	37	85	10	22	321.14
G ¹ / ₂	44	98	12	27	321.16

Technical Data

Max. operating pressure	12 bar
Min. operating pressure	1 bar
Operating temperature	0°C up to +90°C
Mounting position	any
Direction of flow	arrow

Rates of flow

Nominal rates of flow in NI/min.

Inlet pressure p ₁ [bar]		2	4	6	8	10	12
321.11	G ¹ / ₈	450	750	1000	1700	1950	2267
321.12	G ¹ / ₄	1000	1667	2000	3333	4000	4667
321.14	G ³ / ₈	1667	2667	4167	5167	6333	8167
321.16	G ¹ / ₂	2500	3833	5500	7000	8333	10000

Non-Return Valve

Valves



Non-return valves allow flow in one direction while shutting off the flow in the opposite direction. They have a soft seal (Viton) and are available in straight or T-form.

Thread	Dimensions [mm]					Order No.
W	DN	L	i	SW	K	

Non-Return Valve

straight, male threads at both ends

G ^{1/4}	8	49,5	6,5	22	9	392.012
G ^{3/8}	8	53,5	11	22	11	392.013
G ^{1/2}	12	70	13	27	13	392.014
G ^{3/4}	16	77	14	36	14	392.015
G1	22	82	15	46	15	392.016

Non-Return Valve

straight, female threads at both ends

G ^{1/4}	8	45	9,5	22	11,5	392.022
G ^{3/8}	8	47	10	22	11	392.023
G ^{1/2}	12	57	11	27	13	392.024
G ^{3/4}	16	58	14	36	13	392.025
G1	22	68	14	46	16	392.026

Inlet: male threads Outlet: female threads

G ^{1/4}	8	48,5	6,5	22	11,5	392.032
G ^{3/8}	8	53,5	11	22	11	392.033
G ^{1/2}	12	69	13	27	13	392.034
G ^{3/4}	16	72	14	36	13	392.035
G1	22	81	15	46	16	392.036

Inlet: female threads Outlet: male threads

G ^{1/4}	8	46	6,5	22	9	392.042
G ^{3/8}	8	47	10	22	11	392.043
G ^{1/2}	12	58	11	27	13	392.044
G ^{3/4}	16	63	14	36	14	392.045
G1	22	69	14	46	15	392.046

Thread	Dimensions [mm]					Order No.
W	DN	L	i	SW	H	

Non-Return Valve T-form

G ^{1/4}	6	42	11	17	33	566.22
G ^{3/8}	7,5	48	12	22	33	566.24
G ^{1/2}	10	64	15	27	36	566.26

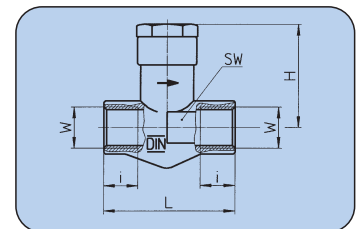
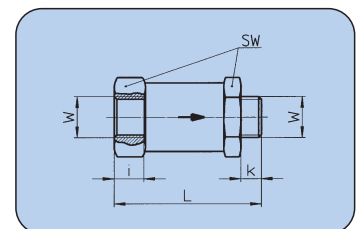
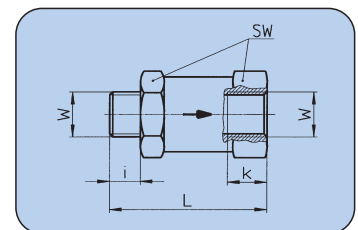
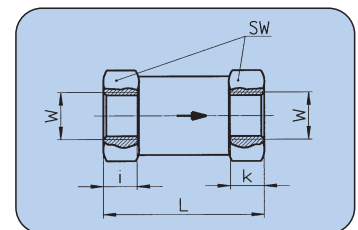
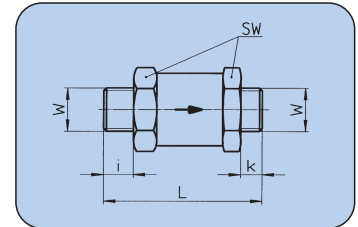
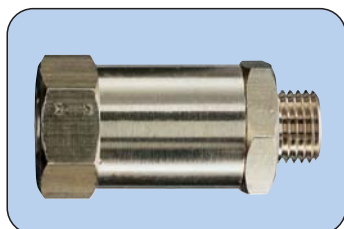
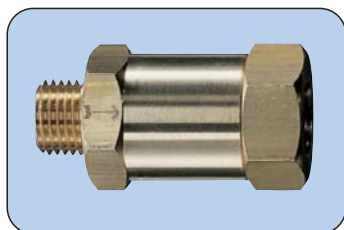
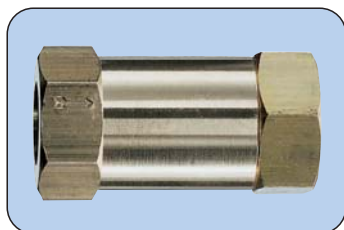
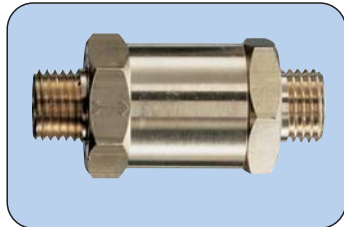

Rates of flow RV straight

Nominal rates of flow in NI/min
at p₁=6bar and Δp=1 bar

Thread	Nominal rates of flow
G ^{1/4} and G ^{3/8}	917 NI/min
G ^{1/2}	1667 NI/min
G ^{3/4}	3167 NI/min
G1	5667 NI/min

Technical Data

Max. operating pressure 16bar

Opening pressure straight ~ 0,1 bar
t-form 0,5 up to 0,8bar

Betriebstemperatur -10°C up to +180°C

Mounting position any

Direction of flow arrow

Material brass, viton

Important: The straight type cannot be used for compressors!



Component-Tested Safety Valve DN6 Safety Valves

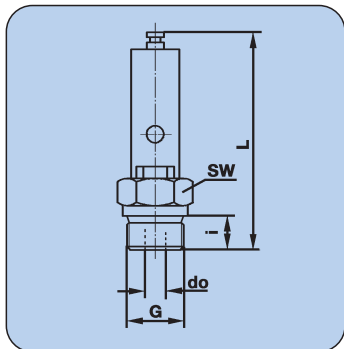

Safety valves serve to blow out non-poisonous and non flammable gases into the atmosphere in order to protect pressure tanks against overpressure.

Please note: Only safety valves that have been set and sealed by us can be delivered with the component symbols, it is thus absolutely necessary to indicate the setting pressure in bar. As functional test, safety valves may be aerated by the way of pulling the haul-off bolt. Repairs may only be carried out by the manufacturer.



Technical Data

Connection thread	G ¹ / ₄ , G ³ / ₈
Max. operating pressure	24 bar (PN24)
Operating temperature	-10°C up to +150°C
Setting range	4,5 up to 24 bar (5 steps)
Opening pressure difference	< 10%
Closing pressure difference	< 10%
Material	brass
Seal	FKM (viton)
locking torque	13Nm

Important: The supply connection to the safety valve should not be < DN6, the pressure drop in the supply connection not > 3%

Tread W	Dimensions [mm]				Set pressure bar	Order No.
	L	i	SW	do		
G ¹ / ₄	65	10	17	6	4,5 - 7,0	469.23
					7,0 - 10,0	469.24
					10,0 - 13,0	469.25
					13,0 - 18,0	469.26
					18,0 - 24,0	469.27
G ³ / ₈	65	10	19	6	4,5 - 7,0	469.33
					7,0 - 10,0	469.34
					10,0 - 13,0	469.35
					13,0 - 18,0	469.36
					18,0 - 24,0	469.37

Component symbols

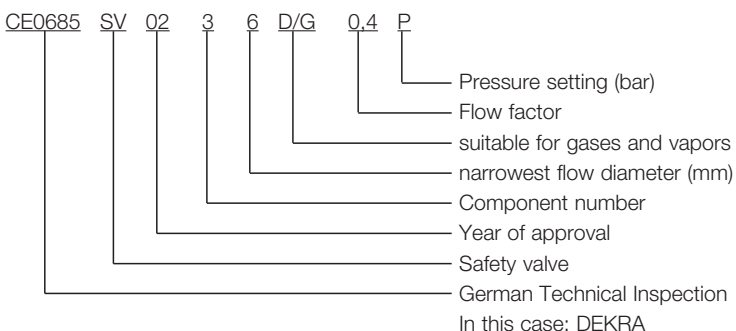

Exhaust Capacity Air

The exhaust capacities indicated in the table are the minimum values reached when air pressure is raised by 10% above the set pressure.

Set pressure bar	exhaust flow capacity (normal condition)	
	m ³ /h	l/min
6	45,5	763
10	92	1540
11	100	1681
14	126	2104
16	143	2387
18	160	2696
20	177	2551
22	194	3234
24	211	3516

Intermediate values can be interpolated.

Definitions

Set pressure = start-to-leak pressure	Beginning of audible leaking
Opening pressure	Valve completely open, maximum blow-off / deflation
Closing pressure	Valve is closed and sealed (tight)
Opening pressure difference	Difference between start-to-leak pressure and opening pressure
Closing pressure difference	Difference between start-to-leak pressure and closing pressure
For example:	Set pressure 12,0bar
	Opening pressure (+10%) 13,2bar
	Closing pressure (-10%) 10,8bar

ewo



Component-Tested Safety Valves DN8

Safety Valves



Safety valves serve to blow out non-poisonous and non-flammable gases into the atmosphere in order to protect pressure tanks against overpressure.

Please note: Only safety valves that have been set and sealed with lead (plumbed) by us can be delivered with the component symbols, it is thus absolutely necessary to indicate the setting pressure in bar. To test their proper functioning, safety valves can be relieved by turning the knurled (thumb) screw to the left. The bearing surfaces and conical seals can be cleaned of impurities by unscrewing the entire upper part - **without** changing the pressure setting. Repairs may only be carried out by the manufacturer.

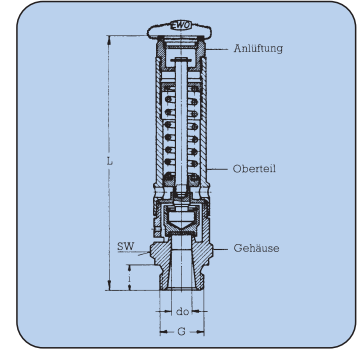

Thread W	Dimensions [mm]					Set pressure bar	Order No.
	L	i	SW	do			
G ^{1/4}	85	10	20	8	1,0 - 1,5	351.221	
G ^{1/4}	85	10	20	8	1,5 - 2,0	351.222	
G ^{1/4}	85	10	20	8	2,0 - 3,0	351.223	
G ^{1/4}	85	10	20	8	3,0 - 5,0	351.224	
G ^{1/4}	85	10	20	8	5,0 - 7,0	351.225	
G ^{1/4}	85	10	20	8	7,0 - 9,0	351.226	
G ^{1/4}	85	10	20	8	9,0 - 15,0	351.227	
G ^{1/4}	90	10	20	8	15,0 - 20,0	351.421	
G ^{1/4}	90	10	20	8	20,0 - 27,0	351.422	
G ^{1/4}	90	10	20	8	27,0 - 40,0	351.423	
G ^{3/8}	85	10	20	8	1,0 - 1,5	351.241	
G ^{3/8}	85	10	20	8	1,5 - 2,0	351.242	
G ^{3/8}	85	10	20	8	2,0 - 3,0	351.243	
G ^{3/8}	85	10	20	8	3,0 - 5,0	351.244	
G ^{3/8}	85	10	20	8	5,0 - 7,0	351.245	
G ^{3/8}	85	10	20	8	7,0 - 9,0	351.246	
G ^{3/8}	85	10	20	8	9,0 - 15,0	351.247	
G ^{3/8}	90	10	20	8	15,0 - 20,0	351.441	
G ^{3/8}	90	10	20	8	20,0 - 27,0	351.442	
G ^{3/8}	90	10	20	8	27,0 - 40,0	351.443	
G ^{1/2}	87	12	24	8	1,0 - 1,5	351.251	
G ^{1/2}	87	12	24	8	1,5 - 2,0	351.252	
G ^{1/2}	87	12	24	8	2,0 - 3,0	351.253	
G ^{1/2}	87	12	24	8	3,0 - 5,0	351.254	
G ^{1/2}	87	12	24	8	5,0 - 7,0	351.255	
G ^{1/2}	87	12	24	8	7,0 - 9,0	351.256	
G ^{1/2}	87	12	24	8	9,0 - 15,0	351.257	
G ^{1/2}	92	12	24	8	15,0 - 20,0	351.451	
G ^{1/2}	92	12	24	8	20,0 - 27,0	351.452	
G ^{1/2}	92	12	24	8	27,0 - 40,0	351.453	

Definitions

Set pressure = start-to-leak pressure	Beginning of audible leaking
Opening pressure	Valve completely open, maximum blow-off / deflation
Closing pressure	Valve is closed and sealed (tight)
Opening pressure difference	Difference between start-to-leak pressure and opening pressure
Closing pressure difference	Difference between start-to-leak pressure and closing pressure
For example:	Set pressure 12,0 bar
	Opening pressure (+10%) 13,2 bar
	Closing pressure (-10%) 10,8 bar

Technical Data

Connection thread	G ^{1/4} , G ^{3/8} , G ^{1/2}
Max. operating pressure	40 bar (PN40)
Operating temperature	-10 °C up to +180 °C
Setting range	1 up to 40 bar (10 steps)
Opening pressure difference	< 10 %
Closing pressure difference	< 10 % (under 3 bar ≤ 0,3 bar)
Built-in position	vertical
Material	brass
Seal	FKM (viton)
Leading	aluminum
Locking torque	13 Nm

Important: The supply connection to the safety valve should not be < DN8, the pressure drop in the supply connection not > 3%.

Component symbols

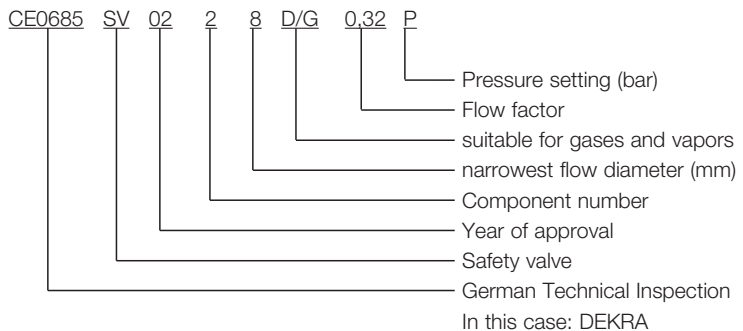

Exhaust Capacity Air

The exhaust capacities indicated in the table are the minimum values reached when air pressure is raised by 10% above the set pressure.

Set pressure bar	exhaust flow capacity (normal condition)	
	m ³ /h	l/min
1	23,5	394
2	35,5	592
4	59	985
6	63	1380
8	106	1773
10	130	2168
12	154	2562
14	177	2957
16	201	3350
18	225	3745
20	248	4138
22	272	4533
25	307	5124
30	367	6110
35	426	7095
40	485	8080

Intermediate values can be interpolated.



Component-Tested Safety Valve DN 10 Safety Valves

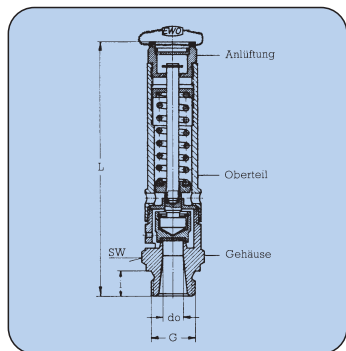

Safety valves serve to blow out non-poisonous and non-flammable gases into the atmosphere in order to protect pressure tanks against overpressure.

Please note: Only safety valves that have been set and sealed with lead (plumbed) by us can be delivered with the component symbols, it is thus absolutely necessary to indicate the setting pressure in bar. To test their proper functioning, safety valves can be relieved by turning the knurled (thumb) screw to the left. The bearing surfaces and conical seals can be cleaned of impurities by unscrewing the entire upper part - **without** changing the pressure setting. Repairs may only be carried out by the manufacturer.



Technical Data

Connection thread	G ^{1/2} , G ^{3/4}
Max. operating pressure	22 bar (PN22)
Operating temperature	-10 °C up to +180 °C
Setting range	2 up to 22 bar (7 steps)
Opening pressure difference	< 10 %
Closing pressure difference	< 10 % (under 3 bar ≤ 0,3 bar)
Built-in position	vertical
Material	brass
Seal	FKM (viton)
Leading locking torque	aluminium 13 Nm

Important: The supply connection to the safety valve should not be < DN10, the pressure drop in the supply connection not > 3%.

Thread	Dimensions [mm]				Set pressure bar	Order No.
	W	L	i	SW do		
G ^{1/2}	120	12	27	10	2,0 - 3,6	351.261
					3,6 - 5,0	351.262
					5,0 - 7,0	351.263
					7,0 - 8,5	351.264
					8,5 - 11,5	351.265
					11,5 - 16,0	351.266
					16,0 - 22,0	351.267
G ^{3/4}	120	12	30	10	2,0 - 3,6	351.271
					3,6 - 5,0	351.272
					5,0 - 7,0	351.273
					7,0 - 8,5	351.274
					8,5 - 11,5	351.275
					11,5 - 16,0	351.276
					16,0 - 22,0	351.277

Component symbols

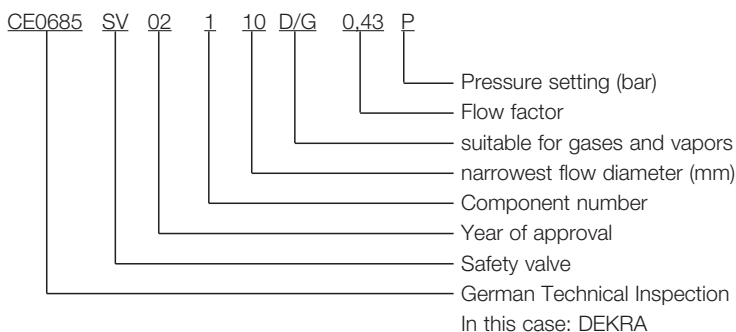

Definitions

Set pressure = start-to-leak pressure	Beginning of audible leaking
Opening pressure	Valve completely open, maximum blow-off / deflation
Closing pressure	Valve is closed and sealed (tight)
Opening pressure difference	Difference between start-to-leak pressure and opening pressure
Closing pressure difference	Difference between start-to-leak pressure and closing pressure
For example:	Set pressure 12,0 bar Opening pressure (+10%) 13,2 bar Closing pressure (-10%) 10,8 bar

Exhaust Capacity Air

The exhaust capacities indicated in the table are the minimum values reached when air pressure is raised by 10% above the set pressure.

Set pressure bar	exhaust flow capacity (normal condition)	
	m ³ /h	l/min
2	74,5	1242
4	124	2068
6	174	2895
8	223	3722
10	273	4548
12	323	5377
14	372	6203
16	422	7032
18	471	7858
20	521	8685
22	571	9513

Intermediate values can be interpolated.

ewo



Component-Tested High-Performance Safety Valve

Safety Valves G1 – G2



This spring-loaded safety valve with a very high blow-off capacity, labeled as **D/G** (models 352.00 to 352.30), will be used for protection of pressure vessels and pressure systems for air and other neutral, non-toxic and non-combustible gases.

The valves with letters **F/K/S** (models 352.40 to 352.70) have a protective cover (stainless steel) and the spring area of the medium is separately. This design allows a usage to secure fixed pressure and vehicle tanks from dust and granular goods.

The valves only can be supplied with a preset pressure, the desired set pressure must be specified with the order. After setting, the valves are labeled and sealed.

For functional testing, the safety valve can be opened by turning the knurled screw.

The bearing surfaces and seals can be cleaned from impurities by unscrewing the upper part **without** changing the pressure setting.

Repairs may only be executed by the manufacturer.



Safety Valve D/G

Thread	Dimensions			DN	Set pressure	Order No.
	[mm]					
W	L	i	SW*	do	p	
G1	177	15	41	24	0,2-35	352.00
G1 1/4	215	22,5	60	32	0,2-30	352.10
G1 1/2	215	22,5	60	32	0,2-30	352.20
G2	282	26	80	48	0,2-30	352.30

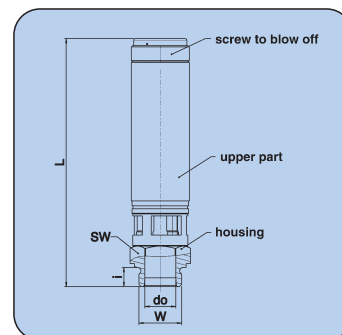

Safety Valve F/K/S

Thread	Dimensions			DN	Set pressure	Order No.
	[mm]					
W	L	i	SW*	do	p	
G1	177	15	41	24	0,2-6	352.40
G1 1/4	215	22,5	60	32	0,2-6	352.50
G1 1/2	215	22,5	60	32	0,2-6	352.60
G2	282	26	80	48	0,2-6	352.70

* SW = wrench size

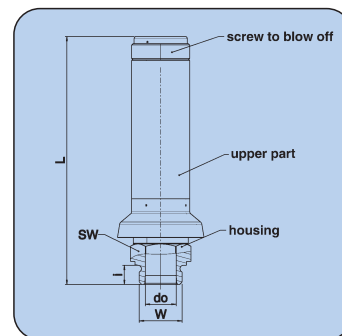

Technical Data

Connection thread	G1, G1 1/4, G1 1/2, G2
Opening pressure difference	< 10%
Closing pressure difference	< 10%
Max. operating temperature	+200°C
Setting range D/G	0,2 up to 30(35)bar
Setting range F/K/S	0,2 up to 6bar
Built-in position	vertical
Material	
housing, upper part, interior parts	brass
seals	FKM (Viton)
pressure spring, protective cover	stainless steel

Component symbols

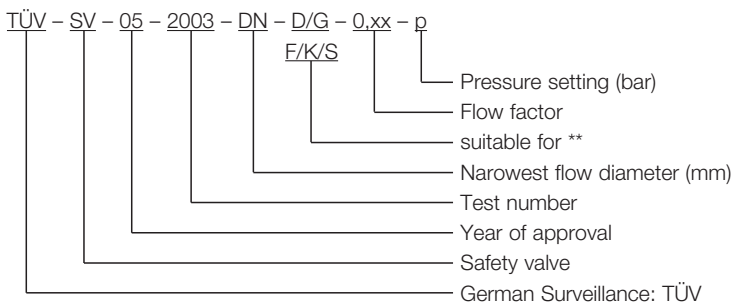

**D/G - for gases and vapors

F/K/S - for blowing air from tanks for liquid, granular or dust media

Options

Stainless steel
NBR or PTFE seals on request!

TÜV - Component Certification: 2003



Component-Tested High-Performance Safety Valve

Safety Valves G1 – G2



Exhaust Capacity Air [Nm³/h]

At max. Pressure exceeding 10% these values are achieved.

Model 352.00 to 352.30 (D/G)

Set pressure [bar]	Connecting thread			
	G1	G1 1/4	G1 1/2	G2
0,2	225	376	376	721
0,3	258	430	430	786
0,4	284	473	473	851
0,5	310	517	517	916
0,6	337	563	563	981
0,7	371	618	618	1046
0,8	399	666	666	1111
0,9	429	715	715	1175
1,0	459	766	766	1370
1,5	604	1007	1007	1827
2,0	749	1249	1249	2325
3,0	1032	1723	1723	3177
4,0	1330	2219	2219	4056
5,0	1601	2671	2671	4962
6,0	1872	3123	3123	5802
7,0	2143	3575	3575	6642
8,0	2413	4027	4027	6034
9,0	2684	4478	4478	6711
10,0	2955	4930	4930	7388
11,0	3226	5382	5382	8066
12,0	3497	5834	5834	8742
13,0	3768	6286	6286	9420
14,0	4039	6738	6738	10097
15,0	4310	7190	7190	10774
16,0	4581	7642	7642	11451
17,0	4851	8094	8094	12128
18,0	5122	8546	8546	12806
19,0	5393	8998	8998	13483
20,0	5664	9450	9450	14160
21,0	5935	9902	9902	14838
22,0	6206	10354	10354	15515
23,0	6477	10806	10806	16192
24,0	6748	11258	11258	16869
25,0	7019	11710	11710	17546
26,0	7289	12162	12162	18224
27,0	7560	12614	12614	18901
28,0	7831	13066	13066	19578
29,0	8102	13518	13518	20255
30,0	8373	13970	13970	20933
31,0	8644	-	-	-
32,0	8915	-	-	-
33,0	9186	-	-	-
34,0	9457	-	-	-
35,0	9727	-	-	-

Applied standards and regulations:

DIN EN ISO 4126-1
AD 2000 data sheets A2
DGR 97/23 EG

Model 352.40 to 352.70 (F/K/S)

Set pressure [bar]	Connecting thread			
	G1	G1 1/4	G1 1/2	G2
0,2	225	376	376	721
0,3	258	430	430	786
0,4	284	473	473	851
0,5	310	517	517	916
0,6	342	571	571	981
0,7	371	618	618	1046
0,8	399	666	666	1111
0,9	429	715	715	1176
1,0	459	766	766	1370
1,2	514	858	858	1514
1,4	571	952	952	1658
1,6	629	1049	1049	1903
1,8	688	1148	1148	2055
2,0	749	1249	1249	2325
2,5	889	1483	1483	2724
3,0	1032	1723	1723	3177
3,5	1165	1943	1943	3583
4,0	1330	2219	2219	4056
4,5	1465	2445	2445	4469
5,0	1601	2671	2671	4962
5,5	1736	2897	2897	5382
6,0	1872	3123	3123	5802

Applied standards and regulations:

DIN EN ISO 4126-1
AD 2000 data sheets A2
TRB 801 Nr. 22 and Nr. 23
DGR 97/23 EG



Blow-Off Valve (Without Component Test) Classic and Mini Blow-Off Valves



DN6

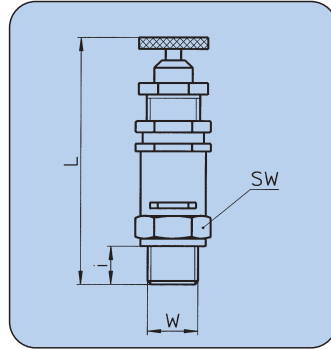

DN3

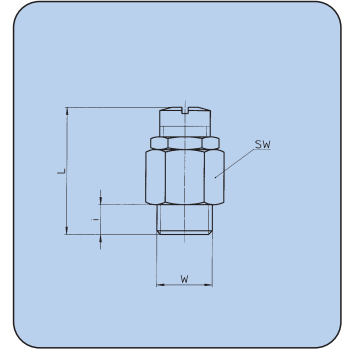

Thread W	Seat	Dimensions [mm]			Set pressure bar	Order No.
		L	i	SW		

Classic Blow-Off Valve DN6

G ^{1/4}	Metal	78	10	17	1,5 - 4,0	259.007
					4,0 - 8,0	259.008
					8,0 - 12,0	259.009
G ^{1/4}	NBR	78	10	17	1,5 - 4,0	259.010
					4,0 - 8,0	259.011
					8,0 - 12,0	259.012

Setted valves are plumbed

Metal seated valves may have slight leakage

Mini Blow Off Valve DN3

G ^{1/8}	NBR	27	7	16	0,2 - 1,0	368.025
					1,1 - 3,0	368.11
					3,1 - 6,0	368.12
					6,1 - 12,0	368.13
					12,1 - 18,0	368.14
					18,1 - 32,0	368.15
32,1 - 60,0	368.16					
G ^{1/4}	NBR	27	7	16	0,2 - 1,0	368.016
					1,1 - 3,0	368.21
					3,1 - 6,0	368.22
					6,1 - 12,0	368.23
					12,1 - 18,0	368.24
					18,1 - 32,0	368.25
32,1 - 60,0	368.26					

Setted safety device on request

Technical Data

	DN6	DN3
Connection thread	G ^{1/4}	G ^{1/8} , G ^{1/4}
Max. operating pressure	40 bar (PN40)	63 bar (PN63)
Operating temperature	NBR Metal	-10°C up to +90°C -10°C up to +180°C (other temperatures upon request)
Setting range	1,5 up to 12 bar	1 up to 60 bar
Opening pressure difference	10% to 15%	~ 20%
Closing pressure difference	15% to 25%	~ 20%
Built-in position		vertical
Material	housing seal	brass metal, NBR

Setting and lead seal at additional charge

Definitions

Set pressure =	Beginning of audible leaking
start-to-leak pressure	Valve completely open, maximum blow-off / deflation
Opening pressure	Valve is closed and sealed (tight)
Closing pressure	Difference between start-to-leak pressure and opening pressure
Opening pressure difference	Difference between start-to-leak pressure and closing pressure
Closing pressure difference	

Exhaust Capacity Air

The exhaust capacities indicated in the table are the minimum values reached when air pressure is raised by 10% above the set pressure.

Classic Blow-Off Valves

start-to-leak pressure	1,5	2	4	6	8	10	12
m ³ /h	10	13	26	42	58	74	90
l/min	165	215	430	700	970	1230	1500

Mini Blow-Off Valves

start-to-leak pressure	1	4	6	10	20	30	40	50	60
m ³ /h	3	12	18	30	60	90	120	150	180
l/min	50	200	300	500	1000	1500	2000	2500	3000



Muffler of Sintered Bronze

Mufflers



To reduce the noise of exhaust air on equipment using compressed air, cylinders and valves etc. The strong design makes them suitable for high working pressure and intermittent operation. Can be cleaned with all usual detergents.

Thread	Dimensions [mm]			Order No.
W	L	i	SW	Pore size

with hexagon (fully sintered) 40µm

G ^{1/8}	28,5	4	13	573.1
G ^{1/4}	33	8	17	573.2
G ^{3/8}	36	10	22	573.3
G ^{1/2}	44	12	27	573.6
G ^{3/4}	54	14	32	573.8
G1	66	16	41	573.9

with brass hexagon 40µm

G ^{1/8}	28	6	13	573.11
G ^{1/4}	34,5	8	16	573.12
G ^{3/8}	40,5	7,5	19	573.13
G ^{1/2}	46	10	24	573.16
G ^{3/4}	50	10	30	573.18
G1	60,5	11,5	36	573.19

flat type with hexagon 100µm

G ^{1/8}	13	6	13	573.21
G ^{1/4}	16,5	8	16	573.22
G ^{3/8}	16,5	7,5	19	573.23
G ^{1/2}	19	10	24	573.26
G ^{3/4}	19	10	30	573.28
G1	22	12	36	573.29

flat type with slot 50µm

G ^{1/8}	5	-	-	573.31
G ^{1/4}	6	-	-	573.32
G ^{3/8}	7	-	-	573.33
G ^{1/2}	9	-	-	573.36
G ^{3/4}	8	-	-	573.38
G1	10	-	-	573.39

throttle type adjustable with brass Hex

with brass hexagon and adjustable exhaust volume.

Lockable with counter nut.

				50µm
G ^{1/8}	38-44	8	16	573.41
G ^{1/4}	39-45	8	16	573.42
G ^{3/8}	47-60	10,5	22	573.43
G ^{1/2}	48-61	13	22	573.46
G ^{3/4}	68-92	12	30	573.48
G1	68-92	11,5	36	573.49

throttle type adjustable with knurled

with knurled screw and adjustable exhaust volume.

Lockable by spring power.

				100µm
G ^{1/8}	25-27	6	13	573.51
G ^{1/4}	27,5-29	8	15	573.52
G ^{3/8}	33,5-36	10,5	22	573.53
G ^{1/2}	32-35	10,5	22	573.56
G ^{3/4}	41,5-46	12	30	573.58
G1	39-45	10,5	36	573.59

Technical Data

Max. banking up pressure	16bar
573.11 - 573.19	12bar
573.41 - 573.49	12bar

Operating temperature -10°C up to +180°C

Mounting position any

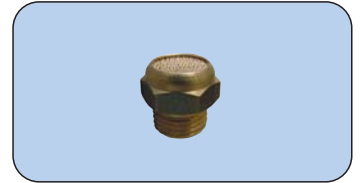
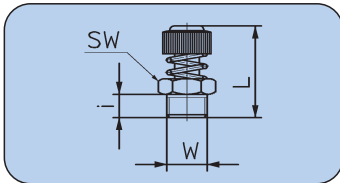
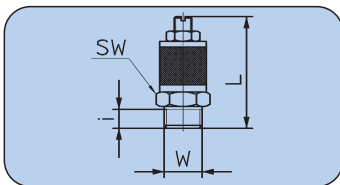
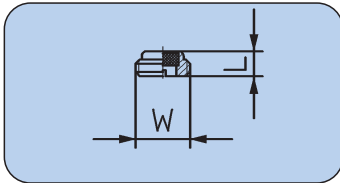
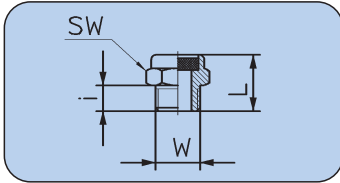
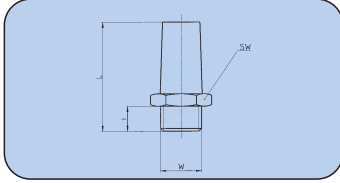

ewo

Muffler of Plastic

Mufflers



To reduce the noise of exhaust air on equipment using compressed air, cylinders and valves etc..

Thread	Dimensions [mm]			Order No.
	W	L	i D	
G ^{1/4}	38,7	8	19,3	573.62
G ^{3/8}	51	10	24	573.63
G ^{1/2}	51	10	24	573.64

Technical Data

Max. banking up pressure:

6 bar

Operating temperatur:

-10°C up to +90°C

Mounting position:

any

Material:

Housing plastic

Damping plastic balls

ewo

Multi-Chamber Muffler

Mufflers

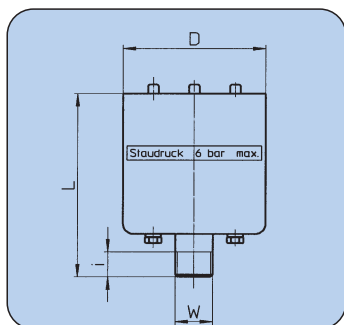

This muffler combines in ideal fashion the three most important requirements of a muffler; high blow-off capacity, short exhaust time, strong silencing effect. The axial air-exhaust at the outlet allows the air to escape in a safe direction. Temperatures up to 90°C in continuous operation, water-resistant and oil-resistant, can be cleaned by washing out with petrol, back pressure: 6 bar.

Thread	Dimensions [mm]			Rates of flow		Sound level [dB(A)]	Order No.
	W	L	i D	[m³/h]	[l/min]		
G ^{1/2}	103	14	80	800	13350	88	391.106
G ^{3/4}	106	16	80	1000	16700	88	391.108
G1	134	18	110	1400	23350	88	391.109
G1 ^{1/4}	140	20	110	1900	31700	89	391.110
G1 ^{1/2}	172	24	150	3200	53400	91	391.111
G2	172	24	150	3400	56700	92	391.112

Technical Data

Max. banking up pressure

6 bar

Operating temperatur

-10°C up to +90°C

Mounting position

any

Material

Steel housing

galvanized

Perforated plates

galvanized

Polyester feltpads

resistant to ageing

COMPRESSED GAS, s.r.o.

predaj
a servis
kompresorov



Viac na www.kompresory-servis.sk

Reed pen pressure gauges with vertical and horizontal connection. Diameter 40, 50 and 63mm. Black dial with white scales and figures. Display ranges 0 to 10, 16, 25bar. The display range should be used between $\frac{2}{3}$ to $\frac{3}{4}$, i.e. a pressure regulator with a display range 0,5 to 10bar is equipped with a pressure gauge with display range 0 to 16bar precision class 2,5 (1,6). Housing plastic (ABS).

Pressure Gauge EN837-1

Article	Display range	Thread	Ground/Imprint	Order No.
ø 40, horizontal				
• Brass thread	0 - 2,5bar	G $\frac{1}{8}$	black/white	640
Plastic panel	0 - 4bar	G $\frac{1}{8}$	black/white	650
Housing ABS black	0 - 6bar	G $\frac{1}{8}$	black/white	660
class 2,5	0 - 10bar	G $\frac{1}{8}$	black/white	670
Tmax 60°C	0 - 16bar	G $\frac{1}{8}$	black/white	680
	0 - 25bar	G $\frac{1}{8}$	black/white	690
ø 40, horizontal				
• Brass thread	0 - 2,5bar	G $\frac{1}{4}$	black/white	708
Plastic panel	0 - 4bar	G $\frac{1}{4}$	black/white	709
Housing ABS black	0 - 6bar	G $\frac{1}{4}$	black/white	714
class 2,5	0 - 10bar	G $\frac{1}{4}$	black/white	723
Tmax 60°C	0 - 16bar	G $\frac{1}{4}$	black/white	734
	0 - 25bar	G $\frac{1}{4}$	black/white	745
ø 40, horizontal, Special model				
• Brass thread	0 - 3 bar	M8x1	black/white	669
Plastic panel	0 - 6 bar	M8x1	black/white	673
Housing ABS black	0 - 10 bar	M8x1	black/white	674
class 2,5	0 - 16 bar	M8x1	black/white	675
Tmax 60°C	0 - 25 bar	M8x1	black/white	676
ø 50, horizontal				
• Brass thread	0 - 2,5 bar	G $\frac{1}{4}$	black/white	40
Plastic panel	0 - 4 bar	G $\frac{1}{4}$	black/white	41
Housing ABS black	0 - 6 bar	G $\frac{1}{4}$	black/white	42
class 2,5	0 - 10 bar	G $\frac{1}{4}$	black/white	55
Tmax 60°C	0 - 16 bar	G $\frac{1}{4}$	black/white	85
	0 - 25 bar	G $\frac{1}{4}$	black/white	96
ø 50, horizontal, Special model class 2,5 - T max 60°C				
• Brass thread	0 - 6 bar	G $\frac{1}{4}$	black/white	44
Glass panel	0 - 10 bar	G $\frac{1}{4}$	black/white	57
Steel housing	0 - 16 bar	G $\frac{1}{4}$	black/white	89
ø 50, vertical				
• Brass thread	0 - 16 bar	G $\frac{1}{8}$	black/white	56
Plastic panel	0 - 16 bar	G $\frac{1}{4}$	black/white	70
Housing ABS black	0 - 2,5 bar	G $\frac{1}{4}$	white/black/red	73
class 2,5	0 - 4 bar	G $\frac{1}{4}$	white/black/red	74
Tmax 60°C	0 - 6 bar	G $\frac{1}{4}$	white/black/red	75
	0 - 10 bar	G $\frac{1}{4}$	white/black/red	76
	0 - 16 bar	G $\frac{1}{4}$	white/black/red	77
	0 - 25 bar	G $\frac{1}{4}$	white/black/red	78
	0 - 40 bar	G $\frac{1}{4}$	white/black/red	79
ø 63, horizontal, Special model with brass thread class 2,5 - T max 60°C				
• Housing brass-coloured	0 - 6 bar	G $\frac{1}{4}$	white/black	257
• calibratable	0 - 10 bar	G $\frac{1}{4}$	black/white	208
• with rubber protection	0 - 10 bar	G $\frac{1}{4}$	black/white	356-19
• Steel housing (class 1,6)	0 - 10 bar	G $\frac{1}{4}$	black/white	279
horizontal, with color code display range 0 - 16bar – class2,5 – Tmax 60°C				
• Brass thread	Ø40	G $\frac{1}{4}$	black/white	746
Plastic panel	Ø50	G $\frac{1}{4}$	black/white	105
Sealing ring PA natur Nobü - with captive disk G$\frac{1}{4}$				480-71



Pressure Gauge

Article	Display range	Thread	Ground/Imprint	Order No.
ø 63 horizontal				
• Brass thread	0 - 2,5 bar	G ¹ / ₄	black/white	211
Plastic panel	0 - 4 bar	G ¹ / ₄	black/white	212
Housing ABS black	0 - 6 bar	G ¹ / ₄	black/white	213
class 2,5	0 - 10 bar	G ¹ / ₄	black/white	214
Tmax 60°C	0 - 16 bar	G ¹ / ₄	black/white	215
	0 - 25 bar	G ¹ / ₄	black/white	216
	0 - 40 bar	G ¹ / ₄	black/white	217
	0 - 60 bar	G ¹ / ₄	black/white	218

ø 63 horizontal				
• Brass thread	0 - 2,5 bar	G ¹ / ₄	white/black/red	183
Plastic panel	0 - 4 bar	G ¹ / ₄	white/black/red	184
Housing stainless steel	0 - 6 bar	G ¹ / ₄	white/black/red	185
Glycerin filling	0 - 10 bar	G ¹ / ₄	white/black/red	186
class 1,6	0 - 16 bar	G ¹ / ₄	white/black/red	187
Tmax 60°C	0 - 25 bar	G ¹ / ₄	white/black/red	188
	0 - 40 bar	G ¹ / ₄	white/black/red	189
	0 - 60 bar	G ¹ / ₄	white/black/red	223

ø 63 vertical				
• Brass thread	0 - 2,5 bar	G ¹ / ₄	white/black/red	193
Plastic panel	0 - 4 bar	G ¹ / ₄	white/black/red	194
Housing stainless steel	0 - 6 bar	G ¹ / ₄	white/black/red	195
Glycerin filling	0 - 10 bar	G ¹ / ₄	white/black/red	196
class 1,6	0 - 16 bar	G ¹ / ₄	white/black/red	197
Tmax 60°C	0 - 25 bar	G ¹ / ₄	white/black/red	198
	0 - 40 bar	G ¹ / ₄	white/black/red	199

ø 63 vertical				
• Brass thread	0 - 2,5 bar	G ¹ / ₄	white/black/red	173
Plastic panel	0 - 4 bar	G ¹ / ₄	white/black/red	174
Housing ABS black	0 - 6 bar	G ¹ / ₄	white/black/red	175
class 2,5	0 - 10 bar	G ¹ / ₄	white/black/red	176
Tmax 60°C	0 - 16 bar	G ¹ / ₄	white/black/red	177
	0 - 25 bar	G ¹ / ₄	white/black/red	178
	0 - 40 bar	G ¹ / ₄	white/black/red	179

Safety Pressure Gauge

ø 63 vertical, DINEN562				
• Measure range	0 - 2,5 / 1,5 bar	G ¹ / ₄	white/black	222
Brass thread	0 - 6 / 4 bar	G ¹ / ₄	white/black	234
Plastic panel	0 - 16 / 7 bar	G ¹ / ₄	white/black	364
Steel housing brass-colored	0 - 16 / 8 bar	G ¹ / ₄	white/black	369
class 2,5	0 - 16 / 10 bar	G ¹ / ₄	white/black	290
Tmax 60°C	0 - 40 / 20 bar	G ¹ / ₄	white/black	320
	0 - 40 / 25 bar	G ¹ / ₄	white/black/red	350
	0 - 100 / 50 bar	G ¹ / ₄	white/black	330
	0 - 315 / 200 bar	G ¹ / ₄	white/black	340
	0 - 315 / 230 bar	G ¹ / ₄	white/black	206
	0 - 400 / 300 bar	G ¹ / ₄	white/black	368
	0 - 32 / 0-16 l/min	G ¹ / ₄	white/black/red	203
	0 - 32 / 0-30 l/min	G ¹ / ₄	white/black/red	205

ø 63 vertical, DINEN562 class 2,5 – Tmax 60°C					
• Brass thread	0 - 2,5 / 1,5 bar	G ¹ / ₄	A	white/black	221
Plastic panel	0 - 40 / 26 bar	G ¹ / ₄	A	white/black	314
Steel housing brass-colored	0 - 16 / 10 bar	G ¹ / ₄	S	white/black	291
Acetylene - (A)	0 - 40 / 20 bar	G ¹ / ₄	S	white/black	321
Oxygen - (S)	0 - 315 / 200 bar	G ¹ / ₄	S	white/black	341

Rubber protection for safety pressure gauges ø 63 grey (DIN32503)

E61050

