

Refrigeration Dryers

TECHNOLOGY | PRODUCT RANGE



Our experience guarantees a perfect performance.

SPX Dehydration & Filtration is one of the world leading manufacturers of equipment for the treatment of compressed air, atmospheric air and other gases. Our company has an experience of over 70 years and a unique know-how in this area. This know-how finds its expression in an extensive Deltech program for compressed air treatment: Refrigerated air dryers, adsorption dryers and filters.

REFRIGERATED COMPRESSED AIR DRYERS

The experience accumulated over years is reflected in the particularly exhaustive range of refrigerated air dryers. This extremely reliable equipment offers a long high performance and is thus a profitable and technically interesting investment.

REFRIGERATED AIR DRYER SMARD SC: 5 MODELS UP TO 100 m³/h

The Smard SC dryers series, where a cooling fan is no longer required, is a revolutionary development in the small dryer range.

How it works

MODELS SMARD SC 5 THROUGH SMARD SC 30

Warm saturated air enters the evaporator (A) where it is cooled by refrigerant being controlled by a constant pressure expansion valve (B). Water vapor condenses into a liquid for removal at the moisture separator (C) by an automatic drain (D). The cold, dry air is reheated as it passes through the reheater (E) to prevent pipeline sweating. The static condenser (F) eliminates the need for a cooling fan and simplifies the system.

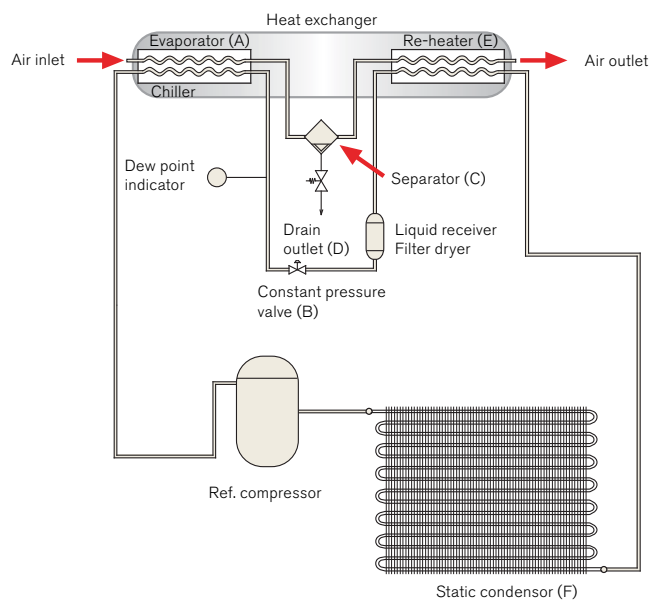

MODELS SMARD 47 THROUGH SMARD 273

Refrigeration Circuit:

A refrigerant compressor (1) and air cooled condenser (2) continuously circulate refrigerant through the system. The filter-dryer (3) removes contaminants from the refrigerant gas. An expansion valve (4) regulates the flow of refrigerant into the 3-in-1 heat exchanger.

Compressed Air Circuit:

Warm, saturated compressed air enters the air-to-air heat exchanger (5) and is cooled by the exiting air. The precooled air (6) enters the air-to-refrigerant heat exchanger (6) and is further chilled causing water vapor to condense. Condensed moisture is collected from the air stream by an integral separator (7) with stainless steel demister. Liquid condensate is removed from the separator by an automatic timed electric drain/ level-controlled automatic drain. Cold air is then reheated in the air-to-air heat exchanger to eliminate pipe line sweat. Clean, dry air exits (8) the dryer and is now conditioned for use.

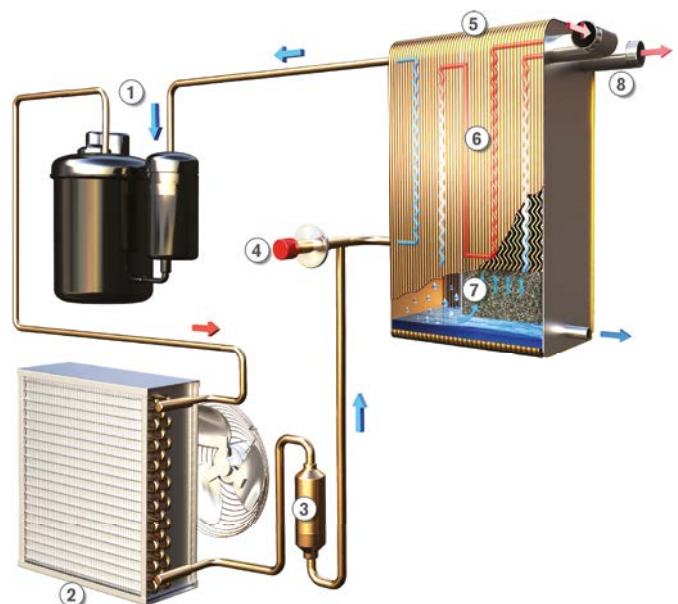

THE SMARD SC AND SMARD SERIES OFFER THE FOLLOWING ADVANTAGES:

- Time-saving package is easy to install.
- Compact structure requires little space
- Fully automatic operation adapts to your system needs without complicated controls.
- High-quality components secure a long service life
- Powder-coated steel construction
- Maximum moisture is removed to a steady 3°C pressure dew point
- Corrosion-free air circuit
- Timer operated drain/level-controlled automatic drain
- On/off switch illuminates with control light
- Coloured dew point indication verifies performance



SMARD SC SERIES MODELS THROUGH 100 m³/h:

- No cooling fan required, provides for extremely quiet operation and reduced maintenance
- Integral moisture separator
- Timer operated drain with isolation valve/strainer
- Compressed air leaves the dryer in warm state

SMARD SERIES MODELS FROM 140 THROUGH 1,700 m³/h

- 3-in-1 stainless steel copper-brazed plate heat exchanger with integral separator ensures optimal dew point performance under all conditions
- Industrial design: compact structures
- Simple filter installation at inlet/outlet
- Dew point indication in main controls



COLDWAVE™ Models Smard LRD, 1,800 through 12,000 m³/h



MOST MODERN TECHNOLOGY AND HIGH QUALITY COMPONENTS

The consistent development of the heat exchanger technology today makes possible an economical use of refrigerated air dryers of high capacities. Due to the use of copper-brazed stainless steel plate heat exchangers, stainless steel moisture separators and copper tubing, a 100% corrosion protection can be guaranteed. Also the mechanical stability is much higher than in the case of aluminium heat exchangers.

The compact design of the plate heat exchangers allows an also very compact dryer design.

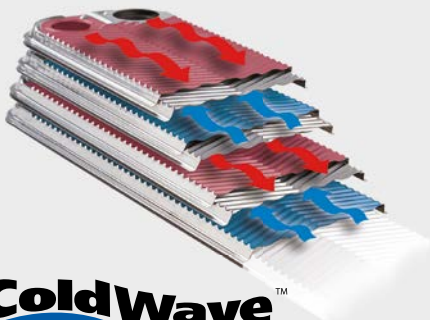

ColdWave™
TECHNOLOGY

NO REFRIGERATED AIR DRYER IS BETTER THAN ITS MOISTURE SEPARATOR

The Smard LRD series combines the principles of centrifugal separation and those of demister technology in a stainless steel moisture separator housing. The condensate which is separated at two different stages is removed from the compressed air circuit through two electronic level-controlled moisture separators. The highly efficient demister-separation stage guarantees an optimal water separation even with very slow air flow. This is a very important condition for a constant pressure due point in cases of fluctuating air demand.

The Smard 656-1635 offer an optional second demister unit, with which a 0,01 micron oil fine filtration by dew point temperature is made possible. By means of the oil filtration at 3°C, the compressed air retains almost the same rest oil as after adsorption with activated carbon

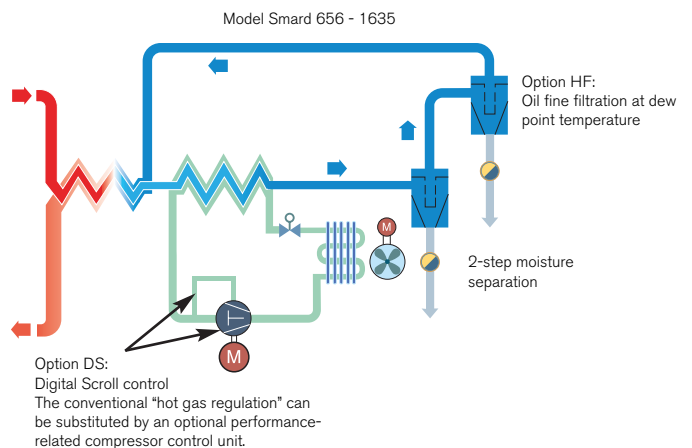

Models DFQ 1,200 through 5,000 m³/h



FREQUENCY-CONTROLLED ENERGY-SAVING DRYERS

- Frequency controlled: Low energy consumption
- Well-proven branded components
- Long service life
- Short payback time

Smart LRD for flow rates from 7,200 through 12,000 m³/h

USER-FRIENDLY OPERATION

Control panels show all important operating parameters and dryer functions, which can also be connected to a higher level system by means of an interface (Smart 656 - 1635). Potential-free alarm contacts are also available for further utilisation.

With the purpose of energy saving, all LRD Smards can be equipped with an energy-saving control system. For dryer capacities from 7,200 to 12,000 m³/h, a standard 50%-100% or 33%-66%-100% adjustment control is used. For dryer capaci-

ties from 1,800 to 5,400 m³/h, the revolutionary Digital Scroll system is offered.

This digital control system regulates the performance of the scroll refrigerant compressor continuously between 10% and 100%. This adjustment is constant and without delay and so it offers - as compared with on/off switching systems or with thermal mass systems - an absolutely constant pressure dew point.



Dryers for special applications

MARINE REFRIGERATION DRYER RD SERIES



- 37 – 3,200 m³/h
- 4 – 10 bar (16 bar optional)
- Corrosion-resistant air circuit copper and stainless steel
- Powder-coated housing
- Halogen-free cables
- Potential-free alarm contact

HIGH PRESSURE REFRIGERATION DRYER H-PET SERIES



- Corrosion-resistant air circuit copper and stainless steel
- Powder-coated housing
- Operating pressure of up to 50 bar
- For PET application

HIGH TEMPERATURE REFRIGERATION DRYER SMART HT SERIES



- Inlet temperature of up to +82° C: directly from the compressor
- Continuously dries and cleans your compressed air
- One dryer for all requirements: Replaces separate after-cooler, separator, dryer and filter package
- includes an integral 3 micron coalescing filter removing contaminants and oil aerosols

Reliable service: Keeping your production running.

ACCESSORIES, SPARE PARTS & SERVICE KITS



- Selection of suitable equipment by our expert team
- Full-service
- Accessories, spare parts & service-kits



SPX ENERGY-SAVING



Energy-saving technologies for future demands

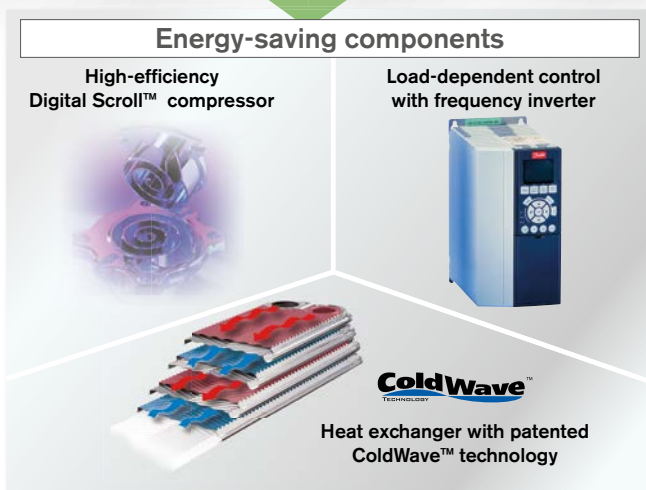

Energy- and cost comparison

Sample calculation: Working hours/year: 8,700
 Costs per kWh in Euro Cent: 0.12

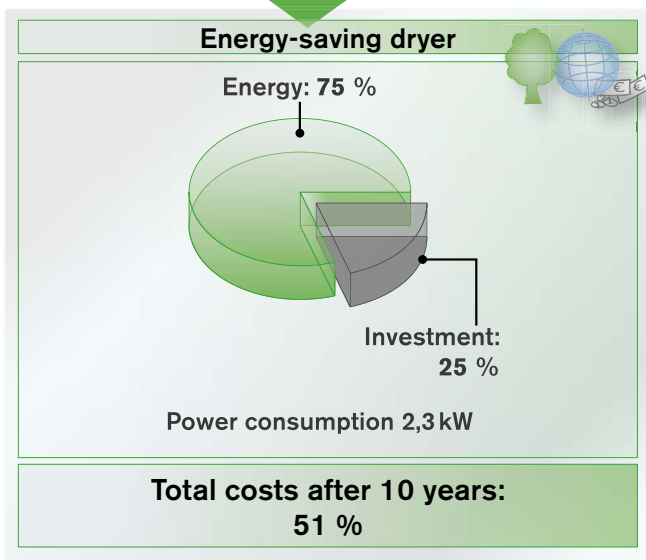
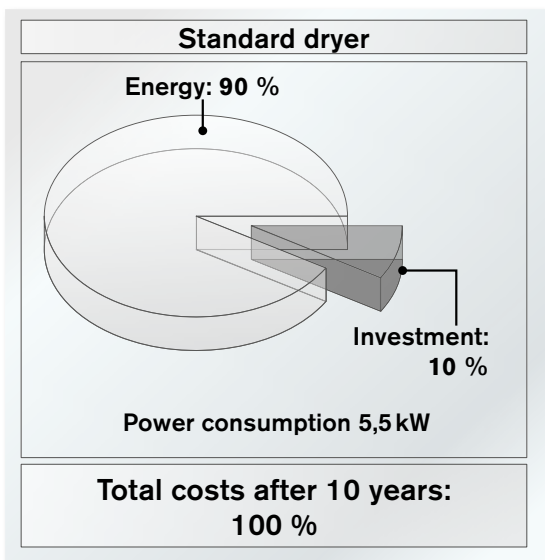

COMPRESSED GAS s.r.o. www.kompresory-servis.sk info@compressedgas.sk

SPX Flow Technology Moers GmbH | Konrad-Zuse-Straße 25 | D-47445 Moers
Tel.: +49 (0) 28 41 / 8 19-0 | Fax: +49 (0) 28 41 / 8 19 83 | E-Mail: csc@dehydration.spx.com
www.deltech-spx.eu | www.spx.com

SPX reserves the right to incorporate our latest design and material changes without notice or obligation. Design features, materials of construction and dimensional data, as described in this bulletin, are provided for your information only and should not be relied upon unless confirmed in writing. Please contact your local sales representative for product availability in your region. For more information visit www.spx.com. The green ">" is a trademark of SPX Corporation, Inc.

ISSUED 03/2013 COPYRIGHT © 2013 SPX Corporation

