

BLUEDIAMOND[®]

CONDENSATE REMOVAL PUMPS



DID YOU KNOW?

This iconic London building holds 2500 MAXIBLUE® PRO pumps. One of many superstructures using BLUEDIAMOND® technology around the world.



BLUEDIAMOND® condensate pumps proudly supports British manufacturing and engineering by designing, developing and producing our pumps in the UK.

CONTENTS

ABOUT US - PAGE 4
THE PUMP RANGE - PAGE 5
MICROBLUE® - PAGE 6
MICROBLUE® (WITH RESERVOIR & DUCTING KIT) - PAGE 7
MINIBLUE® - PAGE 8
MINIBLUE® R - PAGE 9
MAXIBLUE® - PAGE 10
MAXIBLUE® PRO - PAGE 11
MEGABLUE® - PAGE 12
MULTITANK - PAGE 13
SENSING OPTIONS & ACCESSORIES - PAGE 14
FASCIA KIT & ACCESSORIES - PAGE 15
POWER CONSUMPTION - PAGE 16

REFRIGERATION PUMP RANGE

THE PUMP RANGE - PAGE 18
POLARBLUE™ - PAGE 19
ARCTIKBLUE® SLIM - PAGE 20
ARCTIKBLUE® - PAGE 21
SWAP OUT KITS - PAGE 22
THE TECHNOLOGY - PAGE 23
PUMP SELECTOR GUIDE - PAGE 24

BLUEDIAMOND® condensate removal pumps offer the industry leading 3 year warranty. We have faith in our reliability and so can you.

3
YEAR
WARRANTY

ABOUT US

All BlueDiamond® condensate removal products are designed, developed, tooled and manufactured in house, meeting our strict approach to quality, stemming from our UK heritage and wide skill base.

Our team of research and design engineers are dedicated to designing a range of pumps and accessories that not only benefit the end user but also the installer. Offering a new approach to efficiently, quietly and reliably removing large quantities of condensate, our R&D department has an eye for detail, meaning all products purchased are of the very highest standard.

From design to packaging ready for distribution, our team takes pride in every single product despatched from our warehouse facilities. BlueDiamond® consistently invests in both training and development of its team along with new machinery to keep up with ever changing technology.

Each BlueDiamond® product is vigorously tested at the end of the production line, allowing us to ensure our customers are receiving the best product possibly to the ISO 9001 quality standard.

Our ability to manufacture has always been at the forefront of the way we do things at BLUEDIAMOND. Unlike other condensate manufacturers our roots began firmly in Original Equipment Manufacturing (OEM) applications, which has put us far ahead of our competition on design and production capability.



We take great pride in the people that make up BLUEDIAMOND, in particular our Research, Development and Design department. Pulling from nearly three-quarters of a century of pump design knowledge our team of engineers are credited with a number of ground-breaking industry firsts.

BLUEDIAMOND condensate removal pumps are available globally. Using UK & USA warehousing hubs, feeding 4000 trade centres to the global market. Using our own warehousing based all around the world we provide stock to a vast array of wholesalers/distributors.



THE PUMP RANGE

3 YEAR
WARRANTY

MICROBLUE

(Page 6)



MINIBLUE®

(Page 8)



MAXIBLUE®

(Page 10)



MEGABLUE®

(Page 12)



SELF PRIMING

All of the patented pumping principles that BLUEDIAMOND uses are self priming. There's no need to siphon the pump before use due to its ability to run dry.



POWERFUL PUMPING

Flow rates remain powerful when high lift/head applications are applied, This gives you a competitive edge and versatility in every installation.



PUMPS DEBRIS

The BLUEDIAMOND range are the only ductless pump on the market that can remove sediment/ debris with no need of filters or regular servicing intervals.



NO MAINTENANCE

No servicing, no maintenance, no replacement parts. Nothing! A true fit and forget condensate pump.



NO SILENCING DEVICES

Smooth flow rate from the MICROBLUE™ eliminates the necessity for any pulsating free tubing and silencing devices.



QUICK INSTALLATION

Non modular installation with minimum components when setting up. Fewer components means less time wasted on installation. No siphoning devices or check valves required.



RUN DRY

All of the BLUEDIAMOND® pumps have the ability to run dry without burning out. Enabling them to remove any liquids, preventing organic growth inside the tubing.



NO COMPLEX SET UP

BLUEDIAMOND® technology can deal with the variable outputs of condensate without the need for additional sensors or overly complex performance settings.



WHISPER QUIET

Quiet in all stages of operation and not only when set to quiet mode or relying on a soft start setting.



PATENTED

BLUEDIAMOND® Pumps are the only manufacturer of patented Rotary Diaphragm (RD) and GyRok™ technology.



NO WIRELESS CONNECTIONS

Plug in and wireless connections to review pump history or run times before premature failures are not needed due to proven inherently reliable RD technology.



DURABLE DESIGN

Thanks to a strong outer casing the BLUEDIAMOND® range can withstand far rougher treatment than many other pumps on the market.



CAN PUMP SLUDGE

The BLUEDIAMOND range has the unique capability of being able to pump sludge that commonly builds up in refrigeration units.



3 YEAR WARRANTY

Accredited with our own industry pioneering 3 year warranty. We have faith in our reliability and so should you.

MICROBLUE®



3 YEAR
WARRANTY

PERFORMANCE

17dba

MAX FLOW	MAX HEAD	MAX LIFT
5 L/ HOUR	5 METRES	2 METRES

With no additional silencing accessories required, not only is the MICROBLUE® a silent running pump but it can also be mounted in any orientation whilst operating both wet and dry continuously. The MICROBLUE® is a dual voltage pump which uses proven thermistor level sensing technology to remove the risk of stuck or sunken float switches.



UNIT

3.5 KW

SENSING OPTION

MICROBLUE® pump available with:

RESERVOIR	TEMPERATURE SENSOR
X85-001 (HLA-PACK) X85-002 (FSA PACK)	X85-005
	



PUMPS DEBRIS

The MICROBLUE™ is the only ductless pump on the market that can remove sediment/ debris with no need of filters or regular servicing intervals.



NO SILENCING DEVICES

Smooth flow rate from the MICROBLUE™ eliminates the necessity for any pulsating free tubing and silencing devices.

PERFORMANCE

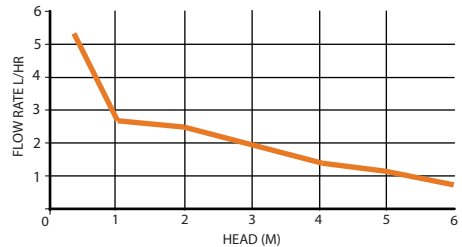

DIMENSIONS (MM)

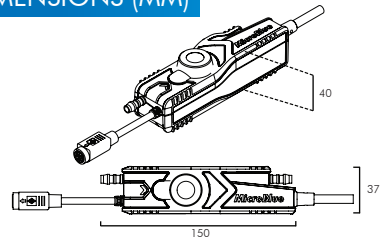

V (VERTICAL)	H (HORIZONTAL)
5 M	0 M
4 M	3 M
3 M	6 M
2 M	9 M
1 M	12 M

DISCHARGE PIPE RUN

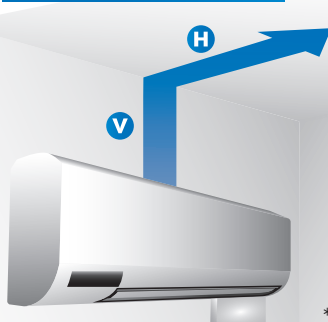

*3.5 KW MAX

The MICROBLUE® can be mounted in any orientation up to 2m away from the air conditioning unit.

MICROBLUE[®]

WITH RESERVOIR & DUCTING KIT



3 YEAR
WARRANTY

PERFORMANCE

17dba

MAX FLOW	MAX HEAD	MAX LIFT
5 L/ HOUR	5 METRES	2 METRES

The MICROBLUE[®] with reservoir and ducting is one of the smartest and more discrete ways to install the MICROBLUE and sits nicely along side any air-conditioning unit. The ducting kit has been designed to make installation easy and enables you to access the pump, reservoir and insulated pipework when required. The kit is equipped with all fixtures, fittings and spacers that you need.



UNIT
3.5 KW

OPTIONS

MICROBLUE[®] pump available in:

DUCTING KIT	DUCTING KIT
X85-507 (IVORY)	X85-508 (WHITE)
 RAL. 9002	 RAL. 9003

PERFORMANCE

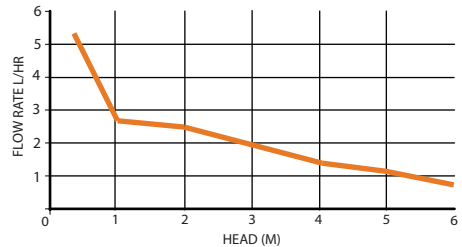

IN THE BOX

1. SCREWS (x6)
2. ELBOW (x1)
3. DUCTING (x1)
4. COLLAR (x1)
5. SPACER (x1)

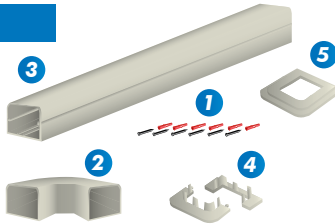

DIMENSIONS (MM)

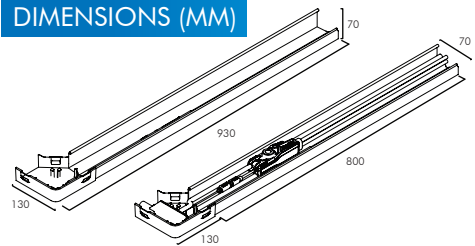

DISCHARGE PIPE RUN



V (VERTICAL)	H (HORIZONTAL)
5 M	0 M
4 M	3 M
3 M	6 M
2 M	9 M
1 M	12 M

The MICROBLUE[®] can be mounted in any orientation up to 2m away from the air conditioning unit.

*3.5 KW MAX

PERFORMANCE

21 dba

MAX FLOW	MAX HEAD	MAX LIFT
8 L/ HOUR	8 METRES	5 METRES

Running either wet or dry, the MINIBLUE® is whisper quiet whilst reliably removing condensate and debris. Inherently reliable whilst self priming it gives peristaltic performance at the price of a piston pump. The MINIBLUE® is small enough to quickly fit, or retro fit, into any existing installation, saving both time and money.



UNIT
3.5-8 KW

SENSING OPTION

MINIBLUE® pump available with:

CR PLUG	TEMPERATURE SENSOR
X87-500	X87-504
	



**RUN
DRY**

All of the BLUEDIAMOND® pumps have the ability to run dry without burning out. Enabling them to remove any liquids, preventing organic growth inside the tubing.



**WHISPER
QUIET**

Quiet in all stages of operation and not only when set to quiet mode or relying on a soft start setting.

DISCHARGE PIPE RUN

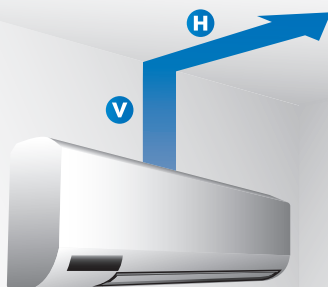

*8 KW MAX

PERFORMANCE

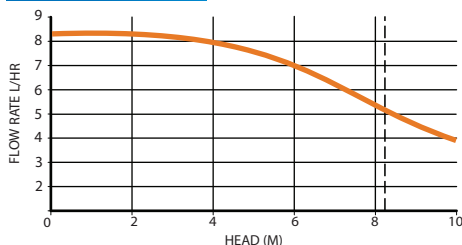

DIMENSIONS (MM)

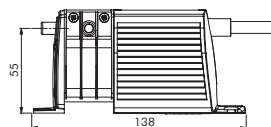
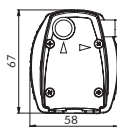

V (VERTICAL)	H (HORIZONTAL)
8 M	0 M
7 M	3 M
6 M	6 M
5 M	9 M
4 M	12 M
3 M	15 M
2 M	18 M
1 M	21 M

The MINIBLUE® can be mounted in any orientation up to 5m away from the A.C

PERFORMANCE

21 dba

MAX FLOW	MAX HEAD	MAX LIFT
8 L/ HOUR	8 METRES	5 METRES

The MINIBLUE[®] R has been designed to combine performance, reliability and installation flexibility. Compact enough to mount remotely and incorporate the electronics needed to operate the unique thermistor controlled reservoir sensor, the MINIBLUE[®] R operates only when condensate is present. Supplied with a ducting kit and dedicated elbow kit to secure our fault free reservoir.

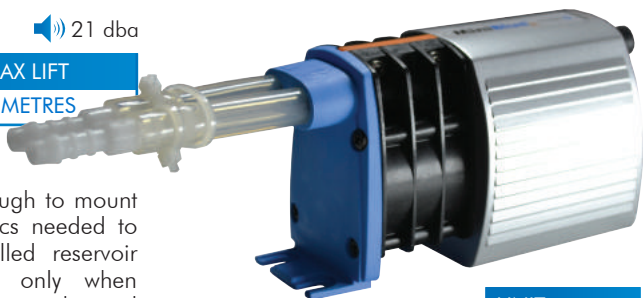

UNIT
3.5-8 KW

SENSING OPTION

MINIBLUE[®] pump available with:

DUCTING KIT	RESERVOIR
X87-507	X87-509
COLOUR: RAL. 9002	
	

PERFORMANCE

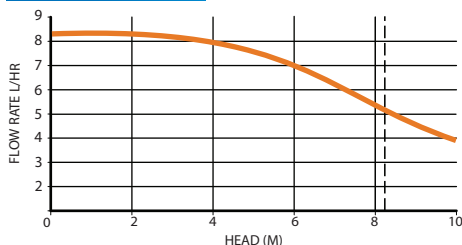

**NO
MAINTENANCE**

No servicing, no maintenance, no replacement parts. Nothing! A true fit and forget condensate pump.



**QUICK
INSTALLATION**

Non modular installation with minimum components when setting up. Fewer components means less time wasted on installation. No siphoning devices or check valves required.

DIMENSIONS (MM)

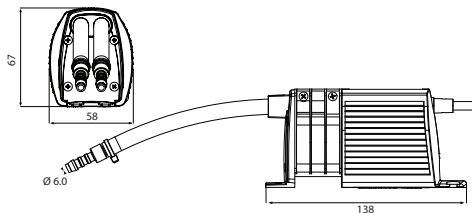

DISCHARGE PIPE RUN

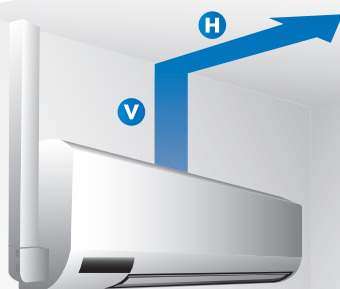

*8 KW MAX

V (VERTICAL)	H (HORIZONTAL)
8 M	0 M
7 M	3 M
6 M	6 M
5 M	9 M
4 M	12 M
3 M	15 M
2 M	18 M
1 M	21 M

The MINIBLUE[®] R can be mounted in any orientation up to 5m away from the A.C

PERFORMANCE

21 dba

MAX FLOW	MAX HEAD	MAX LIFT
14 L/ HOUR	8 METRES	8 METRES

Designed for high humidity environments and with high performance, the MAXIBLUE® is ideally suited for mid range air conditioning systems. Its exceptional reliability is backed by a multi year warranty and with class leading performance/suction lift, the MAXIBLUE® is ideal for installations in environments that are both demanding and expensive to access for maintenance.



UNIT
8-14 KW

SENSING OPTION

MAXIBLUE® pump available with:

RESERVOIR	DRAINSTIK® SENSOR	TEMPERATURE SENSOR
X87-701	X87-702	X85-703
		



**NO COMPLEX
SET UP**

BLUEDIAMOND® technology can deal with the variable outputs of condensate without the need for additional sensors or overly complex performance settings.



**NO WIRELESS
CONNECTIONS**

Plug in and wireless connections to review pump history or run times before premature failures are not needed due to proven inherently reliable RD technology.

PERFORMANCE

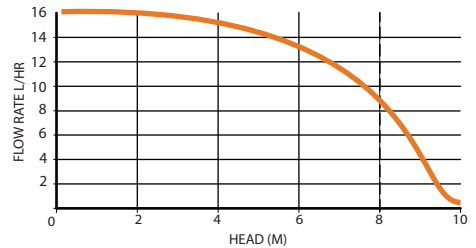

DIMENSIONS (MM)

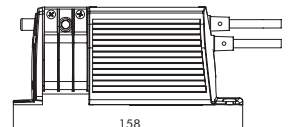
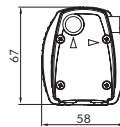

DISCHARGE PIPE RUN

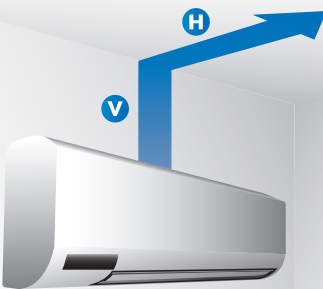

*14 KW MAX

V (VERTICAL)	H (HORIZONTAL)
8 M	0 M
7 M	3 M
6 M	6 M
5 M	9 M
4 M	12 M
3 M	15 M
2 M	18 M
1 M	21 M

The MAXIBLUE® can be mounted in any orientation up to 8m away from the A.C unit.

PERFORMANCE

21 dba

MAX FLOW	MAX HEAD	MAX LIFT
14 L/ HOUR	8 METRES	8 METRES

Designed as a stress-free solution while maintaining the performance of a MAXIBLUE®, the specially formulated package has been created for architects and product specifiers, the MAXIBLUE® PRO package aims to provide all the equipment required during specification in one single purchase, saving you money and more importantly time.



UNIT
8-14 KW

IN THE BOX

PART NO. X87-707

MAXIBLUE® PRO package comes with:

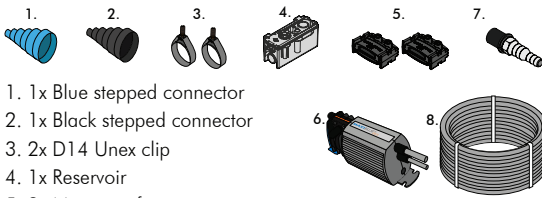

- 1x Blue stepped connector
- 1x Black stepped connector
- 2x D14 Unex clip
- 1x Reservoir
- 2x Mounting feet
- 1x Pump – with 2.5m Mains cable + 5m Alarm cable
- 1x Soil pipe adaptor
- 1x 24m of 6.3mm ID braided PVC discharge hose (marked at meter intervals)

PERFORMANCE

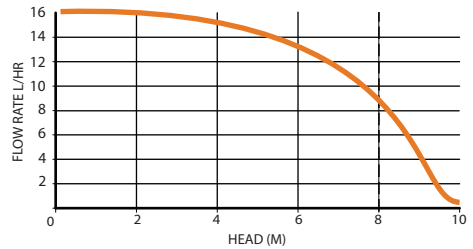

DIMENSIONS (MM)

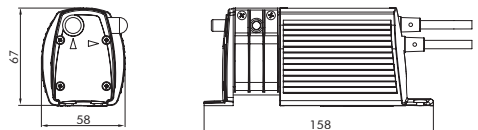

V (VERTICAL)	H (HORIZONTAL)
8 M	0 M
7 M	3 M
6 M	6 M
5 M	9 M
4 M	12 M
3 M	15 M
2 M	18 M
1 M	21 M



The MAXIBLUE® PRO package is the perfect solution for specifiers and architects. Equipped with everything you need to fit your pump the MAXIBLUE® PRO it will save you time when integrating air condition units into your design.



The MAXIBLUE® PRO utilizes our inherently reliable rotary diaphragm technology. Meaning it can pump air, liquid and sediment at the same time without burnouts or failures. A feature that you wouldn't see in common peristaltic pumps.

The MAXIBLUE® can be mounted in any orientation up to 8m away from the A.C unit.

MEGABLUE®



3
YEAR
WARRANTY

PERFORMANCE

23 dba

MAX FLOW	MAX HEAD	MAX LIFT
50 L/ HOUR	20 METRES	7 METRES



The MEGABLUE® has a slimline, lightweight design and is whisper quiet, it also has the performance to overcome installation challenges and uses the BlueDiamond® revolutionary patented principle, making it inherently reliable. With the MEGABLUE® there's no cost penalty up front but big savings on installation and in service beyond.



UNIT
14-50 KW

SENSING OPTION

MEGABLUE® pump available with:

RESERVOIR	TEMPERATURE SENSOR	DRAINSTIK® SENSOR
X87-813	X87-814	X87-820
		

PERFORMANCE

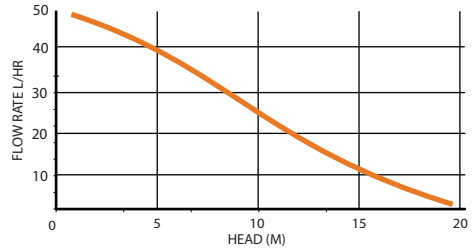

DIMENSIONS (MM)

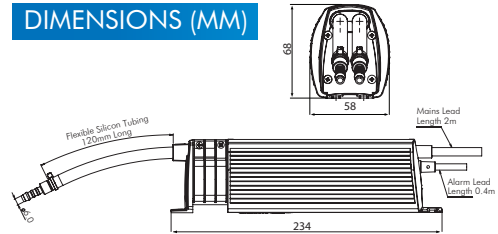

3
YEAR
WARRANTY

Accredited with our own industry pioneering 3 year warranty. We have faith in our reliability and so should you.



BLUEDIAMOND® Pumps are the only manufacturer of patented Rotary Diaphragm (RD) and GyRok™ technology.

DISCHARGE PIPE RUN

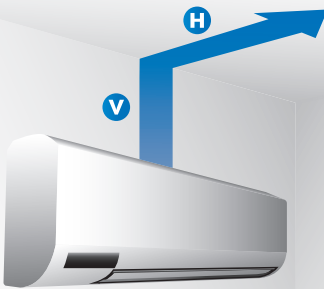

*50 KW MAX

V (VERTICAL)	H (HORIZONTAL)
20 M	0 M
15 M	15 M
10 M	30 M
5 M	45 M
0 M	60 M

The MEGABLUE® can be mounted in any orientation up to 7m away from the air conditioning unit.

MULTITANK

3
YEAR
WARRANTY

The MULTITANK is favoured among architects and design consultants and is available for use with either MEGABLU[®] or MAXIBLU[®] pumps. The tank incorporates an energy efficient solid state level sensor which eliminates the use of moving floats, which often become stuck. By manifolding a number of fan coil units into the 1.5 Litres MULTITANK, it offers the installer complete flexibility surrounding any multi-unit installation.



C21-014

REVOLUTIONARY SENSORY TECHNOLOGY



With no moving parts the MULTITANK offers a reliable alternative to stuck or sunken float switches. Incorporating our patented and proven thermistor technology the hi-low solid state level sensor only runs the pump when condensate is produced. With no moving parts to become clogged or stuck it is an ideal alternative to existing float switches.

DIMENSIONS (MM)

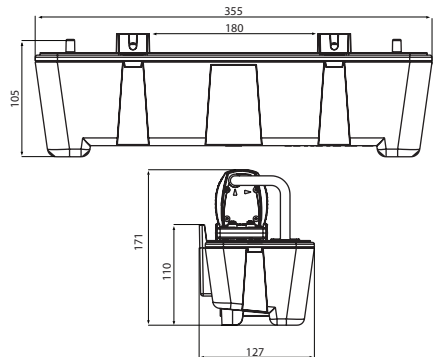

*PUMP SOLD SEPARATELY



OPTION 1: MULTITANK WITH MAXIBLU[®]

Designed for high lift applications (8m) the MULTITANK and MAXIBLU[®] make an ideal combination. Quiet enough for ceiling mounting and powerful enough for remote location makes a wide variety of installation possibilities a lot faster and simpler.

OPTION 1: MULTITANK WITH MEGABLU[®]

Offering exceptional performance the MEGABLU[®] can remove condensate far away and fast. With a head of 20m (6 storeys!) the MULTITANK with MEGABLU[®] can be used as a remote central collection point for condensate drainage.

SENSING & ACCESSORY GUIDE

SENSING OPTIONS

	MICROBLUE™	MINIBLUE®	MINIBLUE ₊ ®	MAXIBLUE®	MAXIBLUE _{REC} ®	MEGABLUE®
TEMPERATURE SENSOR S12-002	✓	✓		✓		✓
DRAINSTIK® S12-004				✓		✓
CR PLUG P02-048		✓	✓	✓		✓
MAXIBLUE® RESERVOIR C21-013	✓		✓	✓	✓	
MEGABLUE® RESERVOIR C21-008						✓

ACCESSORY OPTIONS

	MICROBLUE™	MINIBLUE®	MINIBLUE ₊ ®	MAXIBLUE®	MAXIBLUE _{REC} ®	MEGABLUE®
5M CABLE EXTENSION C13-103	✓	✓	✓	✓	✓	✓
RIGID STEP ADAPTER C01-231	✓	✓	✓	✓	✓	✓
FLEXI STEP ADAPTER C01-226	✓	✓	✓	✓	✓	✓
MULTITANK C21-014			✓	✓	✓	✓
MOUNTING FEET F10-011		✓	✓	✓	✓	✓
FASCIA KIT T01-016	✓					

FASCIA KIT & ACCESSORIES



The BlueDiamond Fascia kit has been specially adapted to fit the MICROBLUE® condensate pump. It can accommodate the pump and the new clear reservoir with the ability to hide various cables and tubing at the same time. The Fascia kit has a easy to use detachable cover and sits nicely under any Air Conditioning Unit.

T01-016

PUMP NOT INCLUDED

IN THE BOX

- A. Cover (x 1)
- B. Base Plate (x 1)
- C. Mounting screws (x 4)
- D. Wall Plug (x 4)
- E. Cable Tie (x 1)
- F. A/C Outlet Tube 100mm (x 1)
- G. Connector Tube 140mm (x 1)

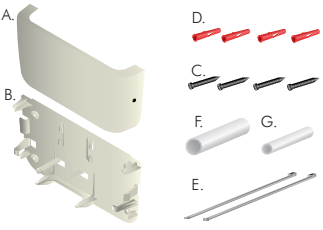

DIMENSIONS (MM)

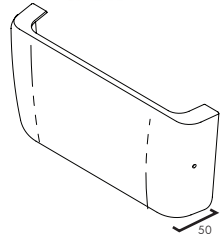
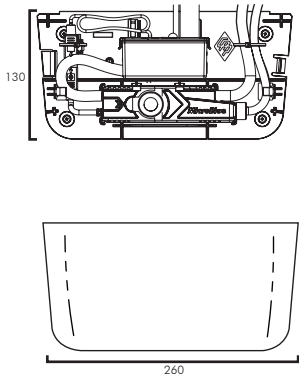

EXTENSION CABLE



C07-226

The 5 metre (6ft) extension cable has been designed to fit the entire BLUEDIAMOND range of pumps and sensors.

MOUNTING FEET



F10-011

Mounting feet have been specially designed to reduce noise in sound critical applications.



POWER CONSUMPTION



The BLUEDIAMOND pump range prides itself on its massively increased power efficiency in comparison to other condensate pump options in the market. In turn our low power consumption gives us a competitive edge and ability to meet low power building regulations. In an ever more environmentally conscious world, the massive financial benefit of using less energy is partnered with the crucial benefit of being kinder to the planet and its resources.

MICROBLUE®

VOLTAGE	240	V
FREQUENCY	50	Hz
CURRENT DRAW	0.04	A
POWER	2.6	W
	9.4	VA
POWER FACTOR	0.29	

MINIBLUE®

VOLTAGE	240	V
FREQUENCY	50	Hz
CURRENT DRAW	0.02	A
POWER	5.5	W
	5.7	VA
POWER FACTOR	0.96	

MAXIBLUE®

VOLTAGE	240	V
FREQUENCY	50	Hz
CURRENT DRAW	0.02	A
POWER	5.5	W
	5.7	VA
POWER FACTOR	0.96	

MEGABLUE®

VOLTAGE	240	V
FREQUENCY	50	Hz
CURRENT DRAW	0.15	A
POWER	12	W
	34	VA
POWER FACTOR	0.36	

Individual units are subject to manufacturing tolerances. Performance may vary



REFRIGERATION
PUMP RANGE

THE PUMP RANGE

POLARBLUE™

Designed for small free standing fridges.



(Page 19)

ARCTIKBLUE®

Designed for standard model fridges.



(Page 21)

ARCTIKBLUE® SLIM

Designed for space premium fridges.

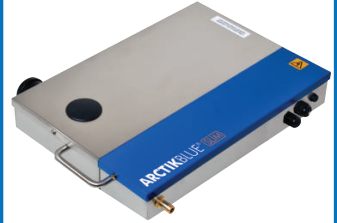

(Page 20)

THERMISTOR SENSOR (ENERGY EFFICIENT)



The presence of condensate trips the hi-low solid state level sensors to switch the pump on/off. This means that the pump is run only when condensate is produced and the alarm shuts off the unit in the case of a fault, restarting when clear.

The slim filter probe, which houses the water sensors and high level alarm has no moving parts to become clogged or stuck making it an ideal alternative to existing float switches.

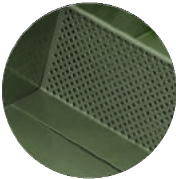

FILTRATION

Protecting the sensors is our swap out guard, the filter element can be changed over as a complete assembly during preventative maintenance service schedules. The main tray is also protected against objects larger than Ø2.5mm allowing the pump to remove condensate, sludge and debris.

PUMPS SLUDGE & SLIME

A common problem with refrigeration units is the build-up of slime and sludge. What others see as a problem that can be solved by after market cleaning products, our patented design can simply pump and remove that from the system without premature failure.



PERFORMANCE

MAX FLOW	MAX HEAD
14 L/ HOUR	8 METRES

A compact and slim unit designed for mounting directly underneath 'Grab & Go' display units. Specifically designed to offer the most energy efficiency solution for smaller convenience stores. The POLARBLUE™ maintains the required flexibility when changing the store layout. The POLARBLUE™ is a great solution to limited space applications with its low profile.

Designed for:
Small drink cabinets



POLARBLUE®

X87-846

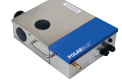

WATER TANK CAP.	PUMP ON/ OFF	ALARM ON VOL.
3 LITRES	330 ML	2000 ML



**SPACE
CONSCIOUS**

The POLARBLUE™ is half the size of the ARCTIKBLUE® range making it ideal for space conscious applications such as small free standing fridges.



**CAN PUMP
SLUDGE**

The POLARBLUE™ has the unique capability of being able to pump sludge that commonly builds up in refrigeration units.

PERFORMANCE

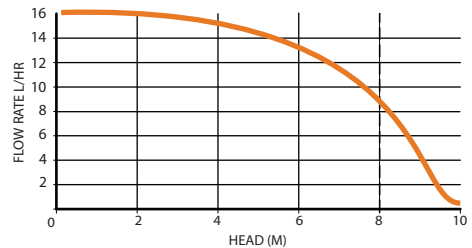

DIMENSIONS (MM)

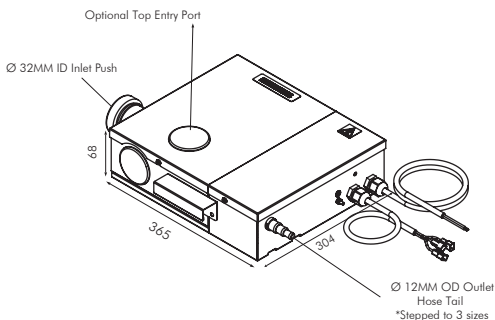

ALARM SIGNAL	MAX ALARM RATING
0 volt relay	5A 250v AC

INPUT VOLTAGE

230V AC, 50/60 Hz

INLET FITTING	OUTLET FITTING
Ø 32MM ID PUSH FIT CONNECTOR	Ø 12MM OD HOSE TAIL STEPPED 3 SIZES
	Ø 9.5MM (5/8")
	Ø 12.7MM (1/2")
	Ø 15.5MM (3/8")

PERFORMANCE

MAX FLOW	MAX HEAD
50 L/ HOUR	20 METRES

The market leading lowest profile dairy pump available. The ARCTIKBLUE Slim easily sits below even the lowest profile kick-plates. Utilising the same pump as the already proven standard ARCTIKBLUE the performance and capability to pump the slime, dirt and debris remains the same. Incorporating a low profile dairy pump into the design of a cabinet gives the advantage of additional refrigerated retail space.

*LOWEST PROFILE UNIT ON THE MARKET (68MM)



WATER TANK CAP.	PUMP ON/ OFF	ALARM ON VOL.
4.1 LITRES	330 ML	3600 ML



LOW PROFILE

The ARCTIKBLUE® SLIM has been specially adapted to fit under low profile cabinets where space is at a premium. Reducing the need to bore the trays into the ground.



QUICK INSTALLATION

The ARCTIKBLUE® SLIM has a minimum amount of components when setting up. Fewer components means less time wasted on installation.

PERFORMANCE

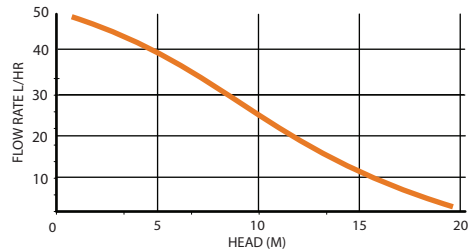

DIMENSIONS (MM)

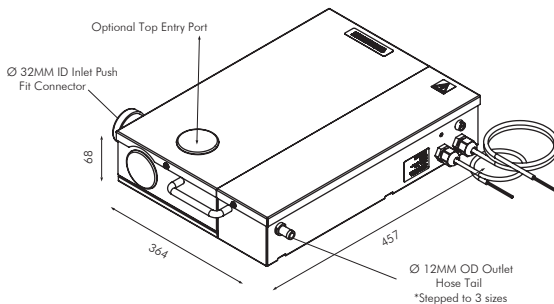

ALARM SIGNAL	MAX ALARM RATING
0 volt relay	5A 240v AC

INPUT VOLTAGE

230V AC, 50/60 Hz

INLET FITTING	OUTLET FITTING
Ø 32MM ID PUSH FIT CONNECTOR	Ø 12MM OD HOSE TAIL STEPPED 3 SIZES
	Ø 9.5MM (5/8")
	Ø 12.7MM (1/2")
	Ø 15.5MM (3/8")

PERFORMANCE

MAX FLOW	MAX HEAD
50 L/ HOUR	20 METRES

Designed for:
Large industrial fridges



Proven in service the ARCTIKBLUE® incorporates the MEGABLUE® pump in a tough steel tray. Eliminating stuck float switches, the use of the BLUEDIAMOND® thermistor technology quickly and efficiently removes all the condensate from the dairy pan, reducing the conditions that allow organic growth to build up and block drains.

WATER TANK CAP.	PUMP ON/ OFF	ALARM ON VOL.
4.1 LITRES	330 ML	3600 ML



DURABLE DESIGN

Thanks to a strong steel casing the ARCTIKBLUE® can withstand far rougher treatment than many other cabinet pumps on the market.



CAN PUMP SLUDGE

The ARCTIKBLUE® has the unique capability of being able to pump sludge that commonly builds up in refrigeration units.

PERFORMANCE

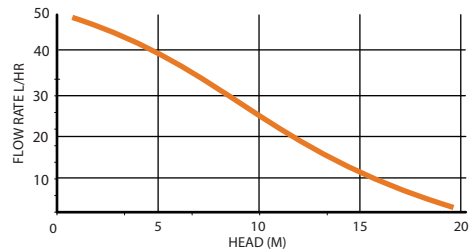

DIMENSIONS (MM)

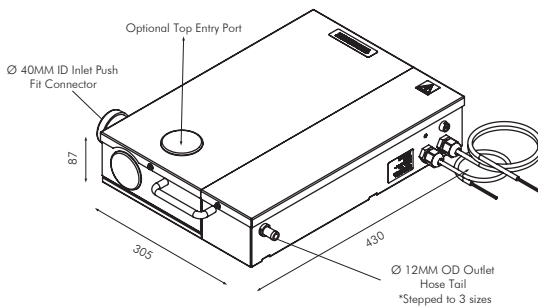

ALARM SIGNAL	MAX ALARM RATING
0 volt relay	5A 240v AC

INPUT VOLTAGE

230V AC, 50/60 Hz

INLET FITTING	OUTLET FITTING
Ø 40MM ID PUSH FIT CONNECTOR	Ø 12MM OD HOSE TAIL STEPPED 3 SIZES
	Ø 9.5MM (5/8")
	Ø 12.7MM (1/2")
	Ø 15.5MM (3/8")

SWAP OUT KITS

POLARBLUE™ SWAP OUT KIT

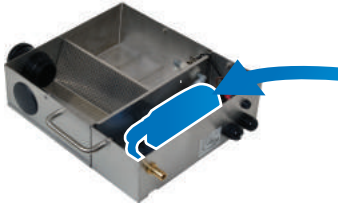

APPLICATION



The POLARBLUE swap out kit consists of the replacement pump and sensor. Its versatile design enables it to pump debris and slime without hampering its performance.

ARCTIKBLUE® SWAP OUT KIT **SLIM**



APPLICATION



The ARCTIKBLUE SLIM swap out kit consists of the replacement pump and sensor. With the ability to pump up to 50 L/hour. The ARCTIKBLUE SLIM uses a faultless design enabling it to maintain a powerful flow.

ARCTIKBLUE® SWAP OUT KIT



APPLICATION



The ARCTIKBLUE swap out kit consists of the replacement pump and sensor. The ARCTIKBLUE has the ability to pump up to 50 L/hour and uses the patented rotary diaphragm technology to run dry, self prime and pump debris.

THE TECHNOLOGY

PUMPS DEBRIS, AIR
& LIQUID

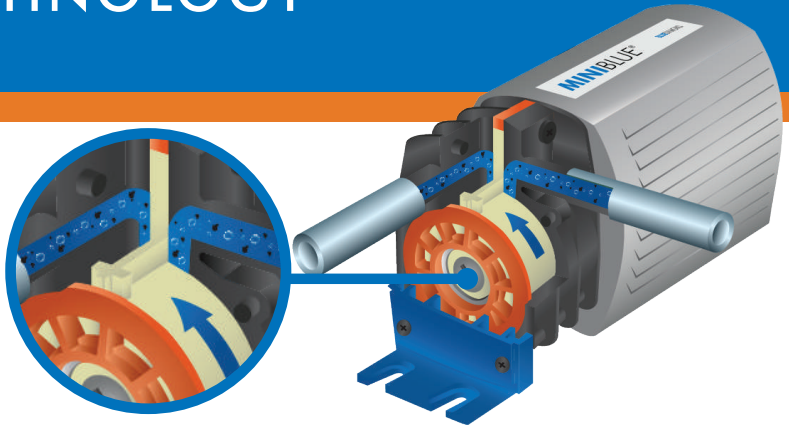

ROTARY DIAPHRAGM PUMPING PRINCIPLE

Rotary diaphragm pumps use unique Charles Austen patented technology. The flow of liquid is initiated by an eccentrically mounted bearing on a drive shaft revolved within a flexible diaphragm. As the shaft rotates, the bearing flexes the diaphragm, squeezing liquid through the pump. These pumps have outstanding self-priming characteristics and are of a valve-less, seal-less design making it suitable for condensate removal.



SELF
PRIMING



POWERFUL
PUMPING



BESPOKE
DESIGN



NO
MAINTENANCE



PATENTED
DESIGN



PUMPS
DEBRIS



RUN
DRY



VISCOUS
PUMPING



COMPACT
SIZE



WHISPER
QUIET

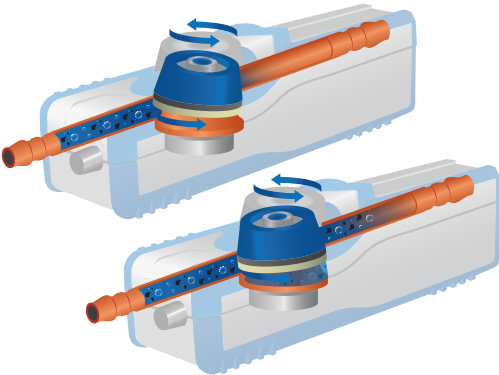

GYROK™ PUMPING PRINCIPLE

With similar capabilities The patented GyRok pumping principle employs a elastomeric conical diaphragm displaced by a number of legs positioned annularly around a nutating drive element. The legs provide control of almost the entire diaphragm, giving outstanding self-priming characteristics. The pump is whisper quiet, able to tolerate extended periods of dry-running and can be mounted in any orientation in a number of locations, both above and below false ceilings.

PUMP ALARM SYSTEMS

FSA- Fail safe alarm, a volt free relay designed to switch the AC unit off, but leaves the pump running continuously when the condensate reaches a critical point in the reservoir.

HLA- High Level Audio is an integral audio and visual alarm. When the condensate is at a critical point within the reservoir, the diagnostic light in the pump will switch from green and will start to flash red with a 2 beep warning every minute. The pump will continue to operate while in alarm mode.

PUMP SELECTOR GUIDE

BLUEDIAMOND® PUMP SELECTOR GUIDE	INDUSTRY		UNIT				PERFORMANCE				INSTALLATION			
	AIR CONDITIONING	REFRIGERATION	3.5 KW	3.5 - 5 KW	5 - 8 KW	8 - 14 KW	14 - 50 KW	MAX FLOW (L/HR)	MAX HEAD (M)	MAX LIFT (M)	SOUND (DBA)	IN UNIT	DUCTING	REMOTELY
MICROBLUE™	✓		✓					5	5	2	17	✓	✓	✓
MINIBLUE®	✓			✓	✓			8	8	5	21			✓
MINIBLUE_R®	✓			✓	✓			8	8	5	21	✓	✓	✓
MAXIBLUE®	✓					✓		14	8	8	21	✓		✓
MAXIBLUE® PRO	✓					✓		14	8	8	21	✓		✓
MEGABLUE®	✓	✓					✓	50	20	7	23			✓
POLARBLUE™		✓						14	8	-	21			
ARCTIKBLUE® (SMA)		✓						50	20	-	23			
ARCTIKBLUE®		✓						50	20	-	23			

*Contact us if you have any OEM or bespoke condensate removal requirements.

WANT TO BECOME A DISTRIBUTOR?

BLUEDIAMOND are always looking to grow their distribution network. For more information on how to become a specialised wholesaler of the range email: info@bluediamondpump.com or visit: www.bluediamondpumpsdistributors.com

S30-622/3

Manufactured by:

